

AmplOn RT Series

5-10kVA

Uninterruptible Power Supply

User Manual

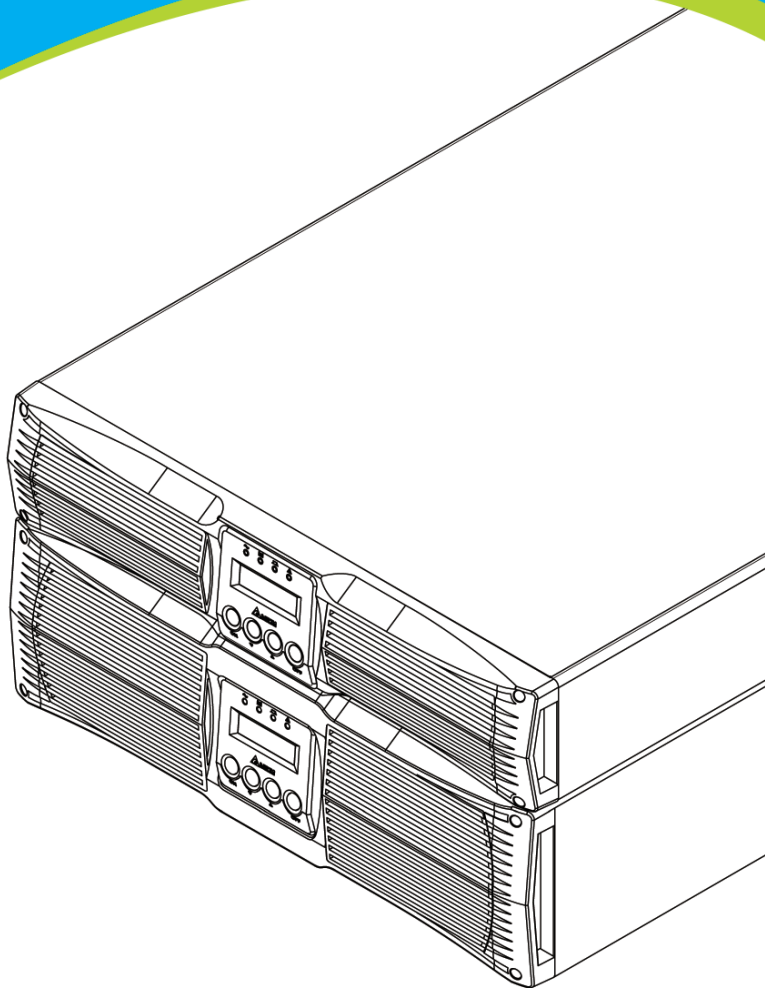



Save This Manual

This manual contains important instructions and warnings that you should follow during the installation, operation, storage and maintenance of this on-line UPS. Failure to heed these instructions and warnings will void the warranty.

DELTA DOC CENTER

Copyright© by Delta Electronics Inc. All rights reserved. The content in this manual belongs to Delta Electronics Inc., hereafter referred to as Delta. No part of this manual can be quoted or reproduced in any form or by any means without the prior written permission of Delta. To continuously improve and develop the product, Delta will make all possible efforts to secure the accuracy and the integrity of this manual. Changes may be made periodically to the information in this manual without obligation to notify any person of such revision or changes.



Table of Contents

Chapter 1: Important Safety Instructions	1
Placement Warnings	1
Connection Warnings	1
Usage Warnings	1
Glossary of Symbols	2
Standard Compliance	2
Chapter 2: Introduction	3
General Overview	3
Package Contents	3
Features	4
Storage	5
Front Panel	6
Rear Panel	7
Chapter 3: Installation	8
Rack Mounting	8
Tower Mounting	8
Connection	10
Chapter 4: Operation	12
UPS Start-up	12
UPS Turn-off	14
LCD Display in Different Operation Modes	14
Firmware Version Look-up	15
Operation Modes	16
Chapter 5: Communication Interface	17
RS232 port	17
Remote Control Port	17
SNMP Slot	18
SMART Slot	19
External Battery Pack Connector	19
Parallel Connector	21

Chapter 6: Optional Accessories -----23
 Optional Accessory List ----- 23
 Optional Accessory Installation----- 24

Chapter 7: Maintenance-----26
 UPS ----- 26
 Battery----- 26
 Fan ----- 26

Chapter 8: Troubleshooting -----27

Chapter 9: Specifications -----28

Chapter 10: Warranty -----29

DELTA DOC CENTER



Chapter 1: Important Safety Instructions

Placement Warnings

- Install the UPS in a well ventilated area, away from excess moisture, heat, dust, flammable gas or explosives.
- Leave adequate space (at least 15cm) around all sides of the UPS for proper ventilation.
- Do not mount the UPS with its front or rear panel facing down at any angle.

Connection Warnings

- The UPS must be well grounded due to a possible risk of current leakage.
- The installation of upstream and downstream protective devices is highly recommended when the UPS is connected to the mains and the load.
- The protective devices connecting to the UPS must be installed near the UPS and must be easily accessible for operation.
- Do not use extension cords to connect the UPS to an AC outlet.

Usage Warnings

- This is a class-A product. In a domestic environment, this product may cause radio interference, in which case, the user is required to take adequate measures.
- The UPS can be used to power computers and associated peripheral devices, such as monitors, modems, cartridge tape drives, external hard drives, etc.
- The external slits and openings in the UPS are provided for ventilation. To ensure reliable operation of the UPS and to protect the UPS from overheating, these slits and openings must not be blocked or covered. Do not insert any object into the slits and openings that may hinder ventilation.
- Before usage, you **must** allow the UPS to adjust to room temperature (20°C–25°C or 68°F–77°F) for at least one hour to avoid moisture condensing inside the UPS.
- Do not put beverage containers on the UPS, battery pack, cabinet or any other accessory associated with the UPS.
- The risk of dangerous high voltage is possible when the batteries are still connected to the UPS even though the UPS is disconnected from the mains. Do not forget to pull out the battery cable to completely cut off the battery source.
- Do not open or mutilate the battery or batteries. The released electrolyte is harmful to the skin

and eyes and may be toxic.

- Do not dispose of the battery or batteries in a fire. The batteries may explode.
- All maintenance services must be performed by qualified service personnel. Forbid opening or removing the cover of the UPS to avoid high voltage electric shock.
- You **must** contact qualified service personnel if either of the following events occur:
 1. Liquid is poured or splashed on the UPS.
 2. The UPS does not run normally after this User Manual is carefully observed.



NOTE: If you use the UPS in an area that generates or incurs dust, you should install a dust filter in the UPS to ensure normal product life and function.

Glossary of Symbols

Symbol	Description	Symbol	Description
	The UPS is in on-line mode.		Protective earthing conductor
	The UPS is in battery mode.		Bonded to ground
	The UPS is in bypass mode.		Positive battery terminal
	The UPS has an internal fault.		Negative battery terminal
	UP button		Phase
	DOWN button		Warning
	Do not connect any computer to the charger detection port.		Note
	DC voltage		

Standard Compliance

- CE
- IEC62040-1-1
- IEC62040-2 C2
- IEC61000-4-2 (ESD) Level 4
- IEC61000-4-3 (Radiated Field) Level 3
- IEC61000-4-4 (EFT) Level 4
- IEC61000-4-5 (Surge) Level 4



Chapter 2: Introduction

General Overview

This RT series UPS, available in 5kVA, 6kVA, and 10kVA, is a true on-line double-conversion UPS providing reliable and consistent sine-wave quality power to your sensitive electronic equipment. It adopts the latest technology and the highest quality components providing output power factor up to 0.9, and its efficiency in on-line mode and in economy mode can reach at maximum 92% and 96% respectively. With its outstanding features, the UPS not only provides safe, reliable and uninterrupted power to your sensitive electronic equipment at all times, but also produces greater electric power efficiency at less cost.

Package Contents

The UPS package contains the following items. Please carefully inspect the UPS and check the included accessories. If there is any damage or anything missing, please immediately contact the dealer from whom you purchased the unit. If the UPS needs to be returned, carefully repack the UPS and all of the accessories using the **original packing material** that came with the unit.

Item	Quantity
● UPS	1 PCS
● User Manual	1 PCS
● Software CD –SMART2000	1 PCS
● Battery Cable	1 PCS
● RS232 Cable	1 PCS
● Parallel Cable	1 PCS
● Tower Stand	1 SET (4 PCS)
● Bracket Ear	1 SET (2 PCS)
● Terminal	5/6kVA: 8 PCS 10kVA: 6 PCS

Features

- True on-line design UPS protects your sensitive electronic equipment from power interruption.
- Wide AC input voltage range (100Vac~300Vac) reduces frequent transfer from AC mode to DC mode to save battery consumption and prolong battery life.
- Smart battery charger design performs auto-charging and reduces the charging time.
- Automatic input frequency detection enables operation at 50Hz or 60Hz.
- The input power factor correction and the high frequency pulse-width-modulated inverter give the UPS excellent performance characteristics in this compact design.
- Battery-Start switch powers on the UPS to provide stable AC power when there is no AC line available.
- Remote Control Port: Use this port to either shut down the UPS completely (REPO) or switch off the inverter only (ROO).
- Built-in RS232 communication port allows the monitoring and management of the UPS via SMART2000 software.
- Optional accessories include Mini SNMP, Mini Relay I/O, Mini USB, Mini ModBus and Mini TVSS cards for network communication, dry contact, USB communication, ModBus communication and surge protection.
- State-of-the-art microprocessor technology performs self-detection and displays the UPS status on LCD.
- Surge protection and EMI filter functions.
- Automatic restart:
 - 1) The UPS will restart in on-line mode automatically right after the AC line resumes following a low battery shutdown.
 - 2) The UPS returns automatically to on-line mode from bypass mode after the overload condition is cleared.
- External battery pack connector is provided to connect an external battery pack to extend the backup time.
- Optional ECO Mode: When the utility input voltage and frequency are within the range of rating voltage $\pm 10\%$ and rating frequency $\pm 6\%$, the UPS will transfer to bypass mode; otherwise, the UPS will transfer to on-line mode to reach higher efficiency.
- Auto-detect the bypass mode voltage: Automatically detects whether the bypass voltage is out of rating voltage (240Vac output: 156~276Vac; 200/ 208/ 220/ 230Vac output: 156~264Vac). If yes, the UPS will stop the supply to the load to protect your electronic equipment.
- Automatically detects and shows whether the fan(s) is operating normally.

- Normal start-up function even when the UPS is not connected to the batteries.

**WARNING:**

Please note that when the UPS is not connected to the batteries, it will not protect your equipment if the utility power is lost.

- Enables set up of “1+1” parallel redundant system (with optional manual bypass box) to increase the system availability and reliability.
- The fan(s) automatically adjusts the fan speed to prolong fan life.

Storage

- **Prior to installation:**

If the UPS needs to be stored prior to installation, it should be placed in a dry area. The allowable storage temperature is between -15°C and +50°C (5°F~122°F).

- **After usage:**

Press the 'OFF' button, make sure the UPS is shutdown, disconnect the UPS from the utility power, remove all equipment from the UPS, and store the UPS in a dry and well-ventilated area at a temperature between -15°C and +50°C (5°F~122°F). Idle batteries must be re-charged fully approximately every three months if the UPS needs to be stored for an extended period of time. The charging time must not be less than 24 hours each time.



NOTE: After storage and before start-up of the UPS, you **must** allow the UPS to adjust to room temperature (20°C~25°C or 68°F~77°F) for at least one hour to avoid moisture condensing inside the UPS.

Front Panel



(Figure 2-a) Front Panel

No.	Item	Description
①	On-line LED	Indicates that the UPS is in on-line mode.
②	Battery LED	Indicates that the UPS is currently in battery mode and the external battery is discharging now.
③	Fault LED	Indicates that the UPS has an internal fault.
④	Bypass LED	Indicates that the UPS is in bypass mode.
⑤	Backlight LCD Display	The LCD display shows the status of the UPS and relevant information.
⑥	ON Button	Press this button for 3~5 seconds to start up the UPS. In on-line mode with utility power available, press this button for 3 seconds to execute the 10-second battery discharge test.
⑦	OFF Button	Press this button for over 3 seconds to shut down the inverter of the UPS.
⑧	△ and ▽ Buttons	Use these two buttons to set up the output frequency, voltage, operation mode and the LCD. Press either △ or ▽ button for more than 3 seconds to disable 'BEEP'.

Rear Panel

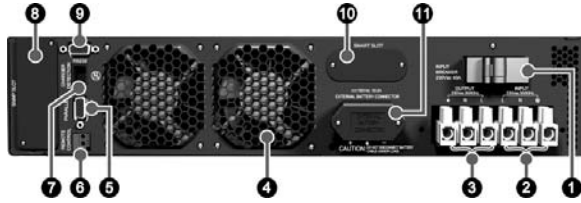

(Figure 2-b)
5kVA/ 6kVA
Rear Panel

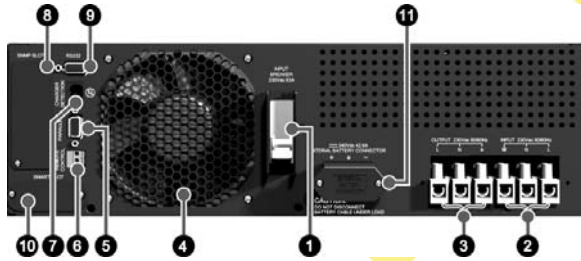

(Figure 2-c)
10kVA Rear Panel

No.	Item	Description
①	Input Breaker	Protects the utility power from further damage when the UPS fails.
②	Input Terminal Block	Connects the UPS to the mains.
③	Output Terminal Block	Connects to the load.
④	Fan	Cools and ventilates the UPS.
⑤	Parallel Connector	For UPS parallel communication, please see Chapter 5 for detailed information.
⑥	Remote Control Port	Shuts down the UPS completely or switches off the inverter only. Please see Chapter 5 for detailed information.
⑦	Charger Detection	Connects to the charger box and detects the charger status.
⑧	SNMP Slot	Accepts SNMP/ Relay I/O/ ModBus card. Please see Chapter 5 for detailed information.
⑨	RS232 Port	Communication interface port. Please see Chapter 5 for detailed information.
⑩	Smart Slot	Accepts Mini SNMP/ Mini Relay I/O/ Mini USB/ Mini ModBus/ Mini TVSS card. Please see Chapter 5 for detailed information.
⑪	External Battery Pack Connector	Connects to the external battery pack. Please see Chapter 5 for detailed information.



Chapter 3: Installation

Rack Mounting

- Use the included bracket ears and screws to mount the UPS in a rack by following the procedures below.
 1. Attach the included bracket ears to the lateral mounting holes of the UPS. See **Figure 3-a**.
 2. Follow steps 1 to 4 to install the UPS in Delta's rail kit (optional). See **Figure 3-b**.
 - Step❶: Adjust the length of the rail according to the rack.
 - Step❷: Tighten the nuts.
 - Step❸: Fix the rail on the rack.
 - Step❹: Insert the UPS in the rack and tighten the screws.
 3. If you want to use a non-Delta rail kit, please only follow Step❹.

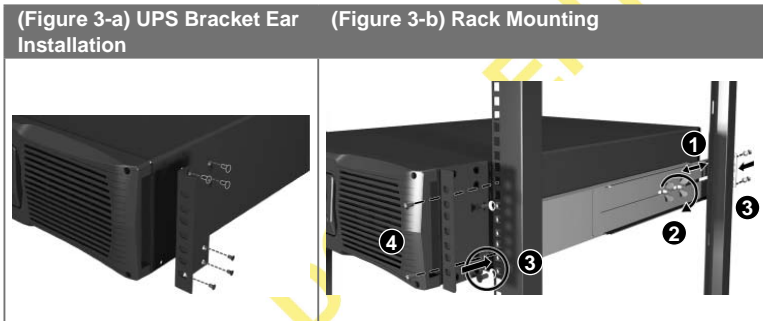

NOTE: If you need the optional rail kit, please contact your local dealer.

Tower Mounting

- Use the included tower stands to mount the UPS in an upright tower position by following the steps below.
 1. Step❶: Assemble the tower stands by inserting the tenons into the grooves according to the size of the UPS. See **Figure 3-c**.
 2. Step❷: Pull out the UPS control panel and rotate it 90° counterclockwise. See **Figure 3-d**.
 3. Step❸: Carefully lift the UPS upright with the Delta logo shown on the control panel facing up. See **Figure 3-e**.
 4. Step❹: Place the UPS inside the tower stands. See **Figure 3-f**.



NOTE: A minimum of two people are required to execute Step❸ and Step❹.

- Leave adequate space (at least 15cm) around all sides of the UPS for good ventilation.

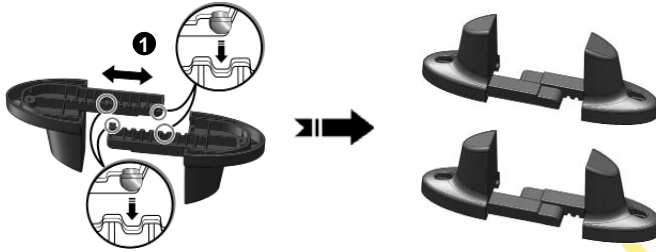
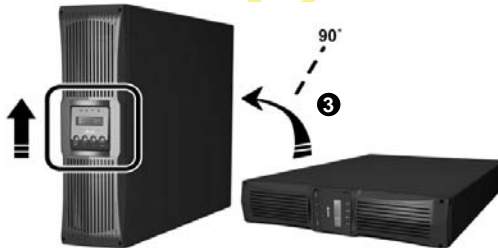
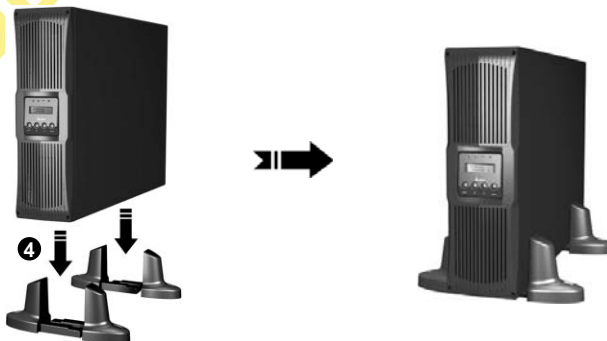
(Figure 3-c) Assemble the Tower Stands**(Figure 3-d) Rotate the UPS Control Panel****(Figure 3-e) Place the UPS Upright****(Figure 3-f) Place the UPS inside the Tower Stands**

Connection

● UPS Connection Warnings:

1. When connecting the UPS to the mains and the load, it is highly recommended that you install the protective devices. The protective devices must use approved components that meet safety certifications. Please refer to the table and diagram below.

UPS Power Rating	Suggested Protective Device	Suggested Supplier
5kVA	C curve- 40 A	NADER: NDM1-63C 40/2 & GE: 674609
6kVA	C curve- 40 A	NADER: NDM1-63C 40/2 & GE: 674609
10kVA	D curve- 63 A	NADER: NDB2-63D 63/2

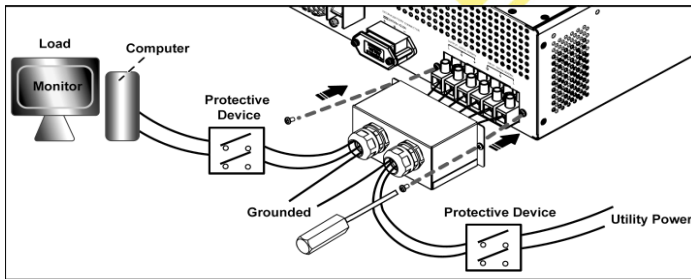

2. Prior to providing any power to the UPS, the UPS must be suitably grounded.
3. The power supply to the UPS must be single-phase in accordance with its nameplate.

● Input/ Output Connection:

1. Please see the figures below for input/ output connection.

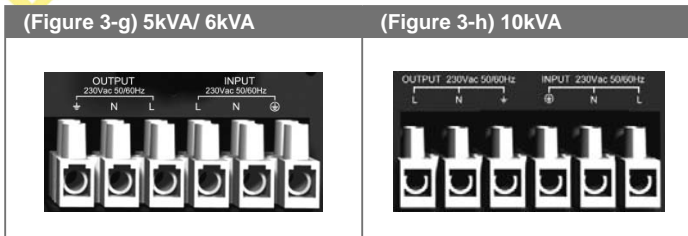

2. Cable selection:

Rating Temperature	5kVA	6kVA	10kVA
60°C	6mm ²	8mm ²	13mm ² or #6AWG (Cu)
75°C	6mm ²	8mm ²	13mm ² or #6AWG (Cu)

(In accordance with National Electrical Code (NEC), please install the suitable conduit and bushing.)

3. When connecting the input/ output power cord, please observe the following rules.

- 1) Turn off the UPS and cut off not only the AC source but also the battery source before connection.
- 2) Calculate the power consumption of the load to ensure that an overload condition will not occur.
- 3) Ensure that the screws are tightly fixed after the connection. The tightening torque should be 18±2Kgf.cm.

4. After the UPS is connected to the utility power, the following sequence of events will occur.

- 1) The fan(s) in the rear panel comes on.
- 2) The LCD will first show the message below.

ONLINE UPS
V00

- 3) After above message appears, the LCD will show the UPS is in 'BYPASS MODE', and the bypass LED  will illuminate (yellow).

BYPASS MODE
00.00kW / 000%



NOTE: All of the readings shown in the LCD diagrams presented in this manual are for reference only. Actual readings depend on the operation of the UPS.



Chapter 4: Operation

UPS Start-up

- **UPS Start-up with AC Input:**

Press the 'ON' button for 3~5 seconds to start up the UPS. After the button is pressed for 3~5 seconds, the system will beep. Release the button and the UPS will start up. The UPS performs self-diagnosis and the LCD automatically shows the following messages in order.

DIAGNOSIS MODE
FREQ OUT=50Hz

- ❶ The UPS will auto detect the input frequency to determine the output frequency (the default value is 50Hz).

DIAGNOSIS MODE
INPUT 000V / 00Hz

- ❷ Auto displays input voltage and frequency.

DIAGNOSIS MODE
RECTIFIER OK

- ❸ Auto checks the rectifier. If ok, it will show RECTIFIER OK.

DIAGNOSIS MODE
CHARGER OK

- ❹ Auto checks the charger. If ok, it will show CHARGER OK.

DIAGNOSIS MODE
BATTERY OK

- ❺ Auto checks the battery. If ok, it will show BATTERY OK.

DIAGNOSIS MODE
DC BUS OK

- ❻ Auto checks the DC BUS voltage. If ok, it will show DC BUS OK.

DIAGNOSIS MODE
INVERTER TEST

- ❼ Auto tests the inverter.

DIAGNOSIS MODE
INVERTER OK

- ❽ When the inverter test result is ok, it will show INVERTER OK.



NOTE: When the LCD shows each screen (❶~❽), the bypass LED  will illuminate (yellow).

ONLINE MODE
00.00KW / 000%

- ❾ Now, the UPS is in on-line mode and the on-line LED  illuminates (green).

- **UPS Start-up with Battery:**

Press the 'ON' button for 3~5 seconds to start up the UPS.

1. When you press the 'ON' button, the LCD will show the message below.

ONLINE UPS
V00

2. After the 'ON' button is pressed for 3~5 seconds, the system will beep. Release the button and the UPS will start up. The UPS performs self-diagnosis and the LCD automatically shows the following messages in order.

DIAGNOSIS MODE
FREQ OUT=50Hz

- ① As there is no input signal available, the UPS will select the default frequency as the output frequency (the default value is 50Hz).

DIAGNOSIS MODE
INPUT 000V / 00Hz

- ② Auto displays input voltage and frequency.

DIAGNOSIS MODE
RECTIFIER OK

- ③ Auto checks rectifier. If ok, it will show RECTIFIER OK.

DIAGNOSIS MODE
BATTERY OK

- ④ Auto executes battery test. If ok, it will show BATTERY OK.

DIAGNOSIS MODE
DC BUS OK

- ⑤ Auto checks DC BUS voltage. If ok, it will show DC BUS OK.

DIAGNOSIS MODE
INVERTER TEST

- ⑥ Auto tests the inverter.

DIAGNOSIS MODE
INVERTER OK

- ⑦ When the inverter test result is ok, it will show INVERTER OK.



NOTE: When the LCD shows each screen (①~⑦), no LED will illuminate.

BATTERY CAPACITY
000V / 000%

- ⑧ The UPS automatically displays the battery capacity and the battery LED  illuminates (green).

UPS Turn-off

In online mode, press the 'OFF' button for 3 seconds to shut down the inverter (the system will beep) and the UPS will transfer to bypass mode. At this moment, the bypass LED  illuminates (yellow) and the LCD shows 'BYPASS MODE'. In backup mode, press the 'OFF' button for 3 seconds to shut down the inverter (the system will beep) and the UPS turns off and the LCD shows the following message.

UPS OFF WAITING
BUS=000V-000V



WARNING:

You can remove the UPS only after the above message is off, the fan(s) stops running, the utility power is shut off and the batteries are removed.

LCD Display in Different Operation Modes

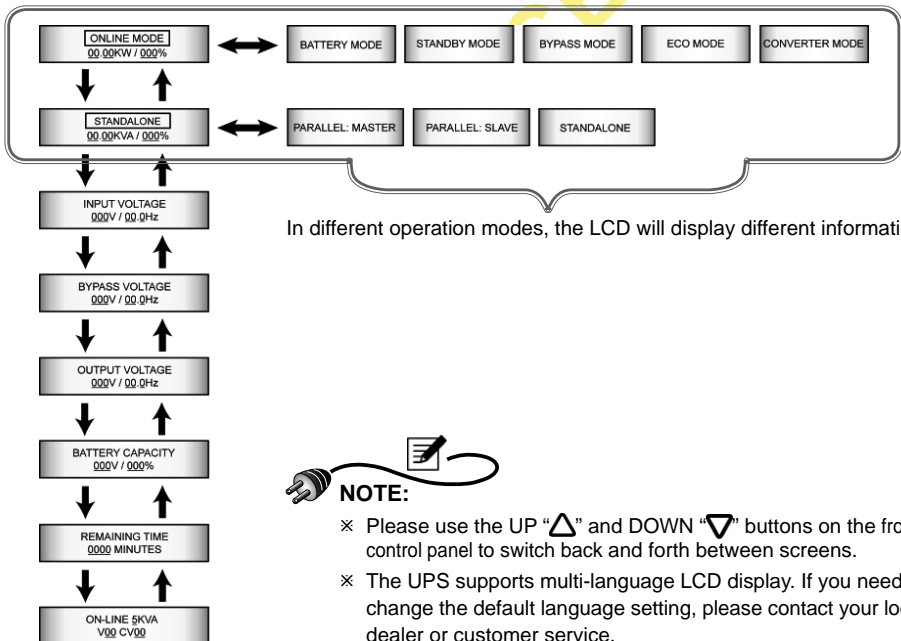

- **LCD Display Messages:**

LCD Message	Meaning
ONLINE MODE	Indicates the UPS is in online mode.
STANDBY MODE	Indicates the UPS is in standby mode
ECO MODE	Indicates the UPS is in ECO mode.
BATTERY MODE	Indicates the UPS is in battery mode.
BYPASS MODE	Indicates the UPS is in bypass mode.
CONVERTER MODE	Indicates the UPS is in converter mode.
STANDALONE	Indicates that there is only one UPS.
PARALLEL: MASTER	Indicates that, in parallel mode, this is the MASTER UPS.
PARALLEL: SLAVE	Indicates that, in parallel mode, this is the SLAVE UPS.
INPUT VOLTAGE	Indicates the input voltage.
BYPASS VOLTAGE	Indicates the bypass voltage.
OUTPUT VOLTAGE	Indicates the output voltage.
BATTERY CAPACITY	Indicates the battery capacity.
REMAINING TIME	Indicates the remaining battery time.
ONLINE XKVA	Indicates the UPS power rating, firmware version and compatible version code.

Firmware Version Look-up

- Check the UPS firmware version from the LCD.

ON-LINE 5KVA
 V00 CV00

V00: UPS Firmware Version

CV00: Compatible Version Code.

- When two units are in parallel, each detects whether the compatible version code of the other is the same. If not, the UPS won't turn on and the alarm message below appears.

UPS1 / UPS2 FW VER
 NOT COMPATIBLE

- If the message above appears, please contact your local dealer to upgrade the firmware.

Operation Modes



- **Online Mode:**

During on-line mode, the on-line LED  illuminates (green). The critical load is supplied by the inverter, which derives its power from the utility AC power, and the UPS charges the batteries as needed and provides power protection to the equipment.

- **Standby Mode:**

In standby mode, the input power is from the utility AC power and the UPS charges the batteries.

- **ECO Mode:**

You can manually set the UPS to ECO mode. In ECO mode, when the utility input voltage and frequency are within the range of rating voltage $\pm 10\%$ and rating frequency $\pm 6\%$, the load is supplied by the utility power and the bypass LED  illuminates (yellow); if out of the range, the load is supplied by the inverter and the on-line LED  illuminates (green).

- **Battery Mode:**

When the UPS is operating during a power outage, the batteries provide DC power, which maintains inverter operation to support the critical load. During battery mode, the battery LED  illuminates (green). The status of the battery is as follows.

Battery Capacity	Buzzer	LCD Display
Full	The alarm beeps once every 10 seconds.	BATTERY CAPACITY 00V/000%
Mid	(Beep is ON for 0.1 sec + Beep is OFF for 9.9 sec).	
Low	The alarm beeps once every 0.5 second. (Beep is ON for 0.1 sec. + Beep is OFF for 0.4 sec).	BATTERY CAPACITY 00V/000%
Under	Long Beep	SHUT DOWN DUE TO DEPLETED BATTERY

- **Bypass Mode:**

During bypass mode, the bypass LED  illuminates (yellow). The critical load is directly supplied by the utility power and the batteries are charged.

- **Converter Mode:**

When the UPS is manually set in converter mode, the output frequency can be set as 50Hz or 60Hz. After the output frequency is set up, the system will automatically disable the bypass function. Please note that once the inverter shuts down, there is no bypass output. During converter mode, the on-line LED  illuminates (green).



Chapter 5: Communication Interface



NOTE: The UPS can still function properly without making the connections below.

RS232 Port

RS232 port (9-pin female connector) is built into the UPS rear panel. You can use the provided RS232 cable to connect the UPS with a computer and use the included CD to install the SMART2000 software to check and monitor the UPS status via a computer.

- **RS232 port provides the following functions:**

1. Monitor UPS status:
Load level, battery status, battery voltage, UPS mode, input voltage, input frequency, output voltage, and unit inside temperature
2. Set shut-down delay time
3. Enable/ disable beep
4. Remote shut-down

- **Pin Assignment:**

1. PIN 2: TXD <Transmitting Data>
2. PIN 3: RXD <Receiving Data>
3. PIN 5: GND <Signal Ground>

- **Hardware:**

1. Baud Rate 2400bps
2. Data Length8 bit
3. Stop Bit1 bit
4. ParityNone



NOTE:

- ※ You can also download the software from the link, <http://59.125.232.140>.
- ※ Before you use the RS232 port, please make sure that you have removed a mini-size card from the SMART slot. Do not use RS232 port and SMART slot at the same time.

Remote Control Port

This interface is for connection to a facility's Remote Emergency Power Off (REPO) circuit. When the UPS is connected to the REPO circuit, it enables emergency shutdown of the UPS and the UPS has no output. Connect this remote control port to a user-supplied normally-closed or normally-open switch. Please refer to **Figure 5-a**.

Figure 5-a: Use a screwdriver to push the area shown by the two black arrows to open the Remote Control Port, and connect the port to a user-supplied normally-closed or normally-open switch.

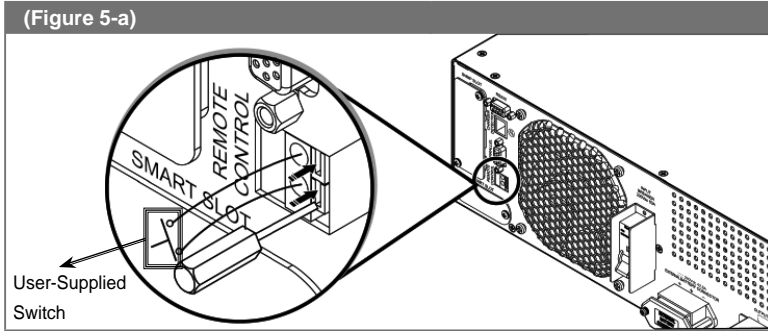

NOTE: This remote control port can also be used for the ROO application, which lets you remotely turn on/ off the inverter. If you need detailed ROO information or ROO setup service, please contact your local dealer or customer service. Please note that this port can only be modified by a qualified service technician.

SNMP Slot

Install an SNMP card in this SNMP slot to remotely control and monitor the UPS status via a network. You can also insert the Relay I/O or ModBus card in this slot to let the UPS have dry contact and Mod-Bus communication functions respectively. Please see **Figure 5-b & 5-c**.

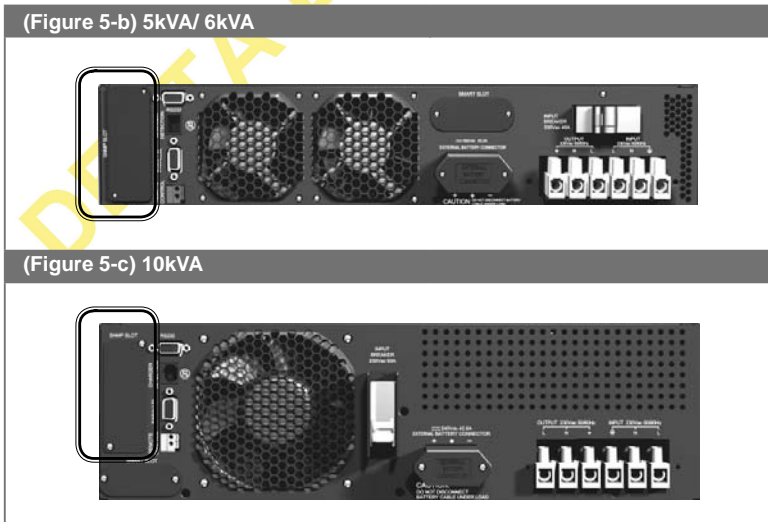

SMART Slot

This SMART slot is for mini-size cards. You can install the Mini SNMP, Mini Relay I/O, Mini USB, Mini ModBus, or Mini TVSS card in this slot to give the system network communication, dry contact, USB communication, ModBus communication, and surge protection functions respectively. Please see **Figure 5-d & 5-e**.

(Figure 5-d) 5kVA/ 6kVA



(Figure 5-e) 10kVA



NOTE: Please note that RS232 port will disable if you insert a mini-size card in the SMART slot.

External Battery Pack Connector

This connector is for connection to an external battery pack. Please see below for relevant information.

- **Battery:**
 1. Charge Voltage:
 - 1) 5kVA/ 6kVA: 217.6Vdc
 - 2) 10kVA: 272.0Vdc
 2. Charge Current:
 - 1) 5kVA/ 6kVA: 0.7A (default)
 - 2) 10kVA: 1.5A (default)

**WARNING:**

- ※ Please refer to the table below to select the charge current for 5kVA/ 6kVA/ 10kVA UPS.
- ※ If you need to modify the charge current default setting, please contact your local dealer or customer service.

5kVA/ 6kVA	Level 1	Level 2	Level 3	Level 4
Total Battery Capacity	5~9Ah	9~17Ah	18~30Ah	27~40Ah
Charge Current	0.7A	1.4A	3A	4A

10kVA	Level 1	Level 2	Level 3	Level 4
Total Battery Capacity	9~17Ah	13~20Ah	20~30Ah	27~40Ah
Charge Current	1.5A	2A	3A	4A

3. Low Battery Shutdown:
 - 1) 5kVA/ 6kVA: 168V±3%
 - 2) 10kVA: 210V±3%
4. The number of batteries:
 - 1) 5kVA/ 6kVA: 12V x 16PCS
 - 2) 10kVA: 12V x 20PCS



NOTE: You can also choose 12V x 15PCS or 12V x 17PCS batteries for 5kVA & 6kVA UPS and 12V x 19PCS or 12V x 21PCS batteries for 10kVA UPS. Please contact your local dealer or customer service for battery selection, connection and replacement.

- **External Battery Pack:**

1. To increase the battery backup time, you can connect several external battery packs to the UPS.
2. Delta external battery pack (optional):
Please refer to the Quick Guide, User Manual or Installation & Operation Guide included in the package of the external battery pack.
3. Non-Delta external battery pack:
When connecting a non-Delta external battery pack with the UPS, please install the fuse or DC breaker first. Do not use an AC breaker. Please follow the actual discharge current to decide the breaker's current capacity.
 - 1) 5kVA/ 6kVA: 200Vdc breaker or 200Vdc fuse is suggested.
 - 2) 10kVA: 250Vdc breaker or 250Vdc fuse is suggested.



NOTE: Please contact your local dealer or customer service for external battery pack connection and replacement.

- **Battery/ Battery Pack Connection Warnings:**

1. Only use the same type of batteries from the same supplier. Never use old, new and different Ah batteries at the same time.
2. The number of batteries must meet UPS requirements.
3. Do not connect the batteries in reverse.
4. Use the voltage meter to measure whether the total voltage, after battery pack connection, is around $12.5\text{Vdc} \times$ the total number of batteries.

**NOTE:**

- ※ Turn off the UPS and cut off the AC source before performing battery/ battery pack replacement.
- ※ A battery can present a risk of electric shock and high short-circuit current.
- ※ Servicing of batteries and battery packs must be performed or supervised by qualified service personnel knowledgeable in batteries, battery packs and the required precautions. Keep unauthorized personnel away from batteries and battery packs.

Parallel Connector

This is for UPS parallel communication. Only two UPS units with the same capacity, voltage and frequency can be coupled via the provided parallel cable to run in parallel mode. The total load will be shared equally by the two units.

- If one of the two parallel units fails:
 1. If the total load is less than a single UPS capacity, the inverter of the failing UPS will shut down to let the load be supplied by the other unit.
 2. If the total load exceeds a single UPS capacity, the inverter of the failing UPS will shut-down and the other unit will overload. At that time, the two units will simultaneously transfer into bypass mode.
- In parallel mode, the two UPS units can share the battery pack to decrease the cost, but the start-up of UPS via battery can't be performed in this mode..
- In parallel mode, the UPS can be repaired without power supply interruption by using a manual bypass box (optional).
- Please see below **Figure 5-f & 5-g** for parallel UPS.

(Figure 5-f) Rack Style

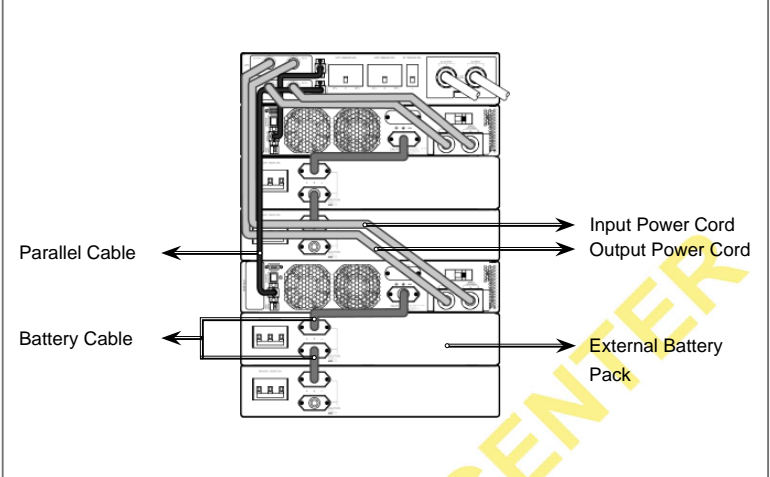

(Figure 5-g) Tower Style

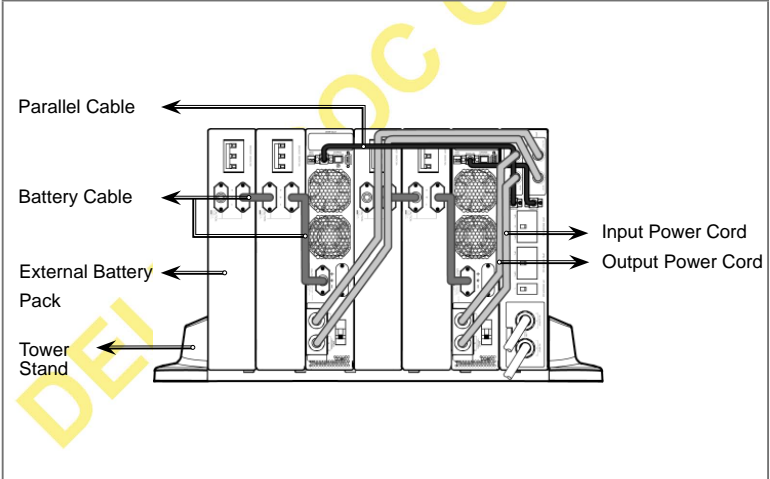

NOTE: If you need UPS parallel service, please contact your local dealer or customer service.



Chapter 6: Optional Accessories

Optional Accessory List

There are several optional accessories available for this RT series UPS. Please refer to the table below for the optional accessories and their part numbers.

No.	Item	Part No.
1.	Manual Bypass Box (for single UPS)	3915100706-S35
2.	Manual Bypass Box (for parallel UPS)	3915100707-S35
3.	Charger Box	CHG252C2D1000-N
4.	Dust Filter	5/6kVA; 3915100835-S00 10kVA; 3915100840-S00
5.	Rail Kit	33129619201
6.	External Battery Pack (with batteries)	5/6kVA; GES161B105700 10kVA; GES201B109700
7.	Empty Battery Pack (without batteries)	5/6kVA; GES161B105700-N 10kVA; GES201B109700-N
8.	EnviroProbe	EMS1000000
9.	SNMP/WEB Card	3915100120-S
10.	Relay I/O Card	3915100147-S
11.	ModBus Card	3915100422-S
12.	Mini TVSS Card	3915100482-S
13.	Mini USB Card	3915100476-S
14.	Mini SNMP Card	3915100473-S
15.	Mini Relay I/O Card	3915100474-S
16.	Mini ModBus Card	3915100748-S

Optional Accessory Installation

This User Manual only presents installation guidelines for the Mini SNMP/ Mini Relay I/O/ Mini USB/ Mini ModBus/ Mini TVSS cards installation. For detailed installation and operation of any other optional accessory, please refer to the Quick Guide, User Guide, or Installation & Operation Guide included in the package of the relevant optional accessory.

● Mini SNMP/ Mini Relay I/O/ Mini USB/ Mini ModBus Card Installation:

1. For 5kVA/ 6kVA UPS:

- 1) Remove the SMART SLOT cover from the rear panel. **(Picture 1)**
- 2) Loosen the top cover's screws to remove the top cover. **(Picture 2)**
- 3) Install the flat cable in the Mini SNMP/ Mini Relay I/O/ Mini USB/ Mini ModBus card. **(Picture 3-1/ 3-2)**
- 4) Insert the Mini SNMP/ Mini Relay I/O/ Mini USB/ Mini ModBus card into the slot and tighten the screws. **(Picture 4)**
- 5) Insert the other end of the flat cable into CNG3. **(Picture 5)**
- 6) Replace the top cover and tighten the screws. **(Picture 6/ 6-1/ 6-2)**

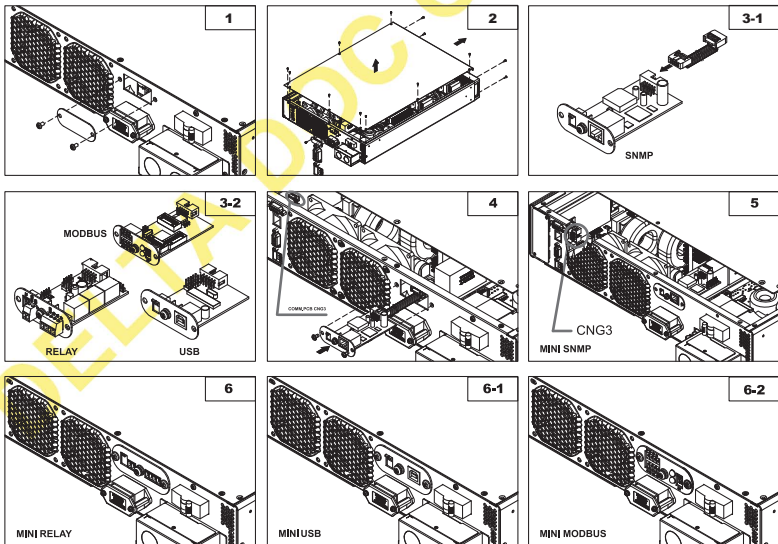

2. For 10kVA UPS:

- 1) Remove the SMART SLOT cover from the rear panel. **(Picture 1)**
- 2) Loosen the top cover's screws to remove the top cover. **(Picture 2)**
- 3) Install the flat cable in the Mini SNMP/ Mini Relay I/O/ Mini USB/ Mini ModBus card. **(Picture 3)**

- 4) Insert the Mini SNMP/ Mini Relay I/O/ Mini USB/ Mini ModBus card into the slot and tighten the screws. **(Picture 4)**
- 5) Insert the other end of the flat cable into CNG3. **(Picture 5)**
- 6) Replace the top cover and tighten the screws. **(Picture 6/ 6-1/ 6-2)**

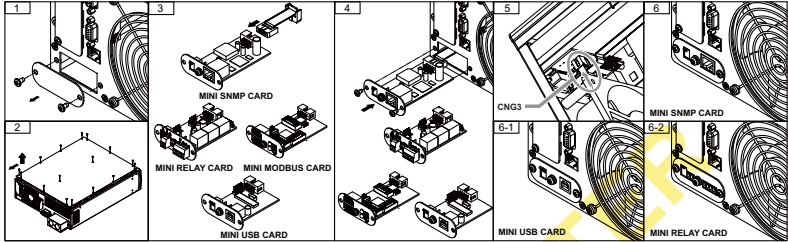

● Mini TVSS Card Installation:

1. For 5kVA/ 6kVA UPS:
 - 1) Remove the SMART SLOT cover from the rear panel. **(Picture 1)**
 - 2) Insert the Mini TVSS card into the slot and tighten the screws. **(Picture 2/ 2-1)**

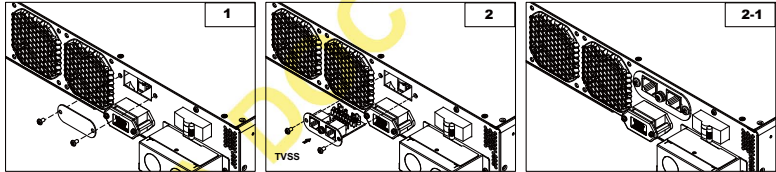

2. For 10kVA UPS:
 - 1) Remove the SMART SLOT cover from the rear panel. **(Picture 1)**
 - 2) Insert the Mini TVSS card into the slot and tighten the screws. **(Picture 2/ 2-1)**

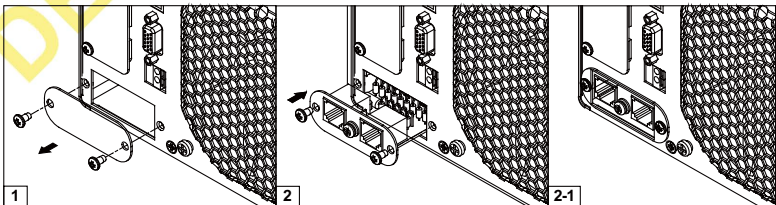

NOTE: Please contact your local dealer for more information about the optional cards.



Chapter 7: Maintenance

UPS

- **UPS Cleaning:**

Regularly clean the UPS, especially the slits and openings, to ensure that the air freely flows into the UPS to avoid overheating. If necessary, use an air-gun to clean the slits and openings to prevent any object from blocking or covering these areas.

- **UPS Regular Inspection:**

Regularly check the UPS every half year and inspect:

1. Whether the UPS, LED, or alarm function has any abnormality.
2. Whether the UPS works in bypass mode (normally, the UPS will work in on-line mode). If yes, check if any error, overload, internal fault, etc. occurs.
3. Whether battery voltage is normal. If battery voltage is too high or too low, find the root cause.

Battery

The RT series UPS uses an airtight lead-acid battery. The battery life depends on the temperature, the usage, and charging/ discharging frequency. High temperature environments and high charging/ discharging frequency will quickly shorten the battery life. Please follow the suggestions below to ensure a normal battery lifetime.

- Keep the usage temperature between 15°C~25°C (59°F~77°F)
- When the UPS needs to be stored for an extended period of time, the battery must be recharged once every three months and the charging time must not be less than 24 hours each time.

Fan

The higher the temperature, the shorter the fan life is. When the UPS is running, please check if the fan(s) works normally and make sure UPS is ventilated properly. If not, replace the fan.



NOTE: Please ask your local dealer or customer service for more maintenance information. Do not perform maintenance if you are not trained for it.



Chapter 8: Troubleshooting

When you see the following problems appear on the LCD, please follow the solutions shown below.

Problem	Possible Cause	Solution
+DC BUS HIGH +DC BUS LOW - DC BUS HIGH - DC BUS LOW BUS OVP FAIL	Output has capacitive load or inductive load.	Decrease the load.
OUTPUT SHORT	1. Phase difference in parallel system. 2. UPS has an internal fault.	Contact the dealer.
OVER TEMPERATURE	Output has short circuit issue.	Check whether output has short circuit or not. If yes, contact the dealer.
OUTPUT SCR FAIL	The UPS temperature is too high.	1. Choose a well-ventilated area. 2. Decrease the load.
BYPASS SCR FAIL	1. Output SCR has no driver signal. 2. Output SCR has short issue.	Contact the dealer.
RECTIFIER FAIL	1. Bypass SCR has no driver signal. 2. Bypass SCR has short issue.	Contact the dealer.
INVERTER FAIL	1. Rectifier has no driver signal. 2. Rectifier has short issue.	Contact the dealer.
I/P FUSE BROKEN	Inverter is damaged.	Contact the dealer.
O/P FUSE BROKEN	Input fuse is broken.	Contact the dealer.
FAN FAIL	Output fuse is broken.	Contact the dealer.
OVERLOAD	Fan is damaged or stuck.	Contact the dealer.
PARALLEL FAULT	UPS is overloaded.	Remove the unnecessary load.
NO BATTERY	Parallel cable is not well connected.	Check whether the parallel cable is well connected.
CHARGER FAIL	Battery is not connected.	Check whether the battery and battery cable are well connected.
REDUNDANCY LOSS	Charger is damaged.	Contact the dealer.
UPS1/ UPS2 FW VER NOT COMPATIBLE	Overload causes redundancy failure.	1. Decrease the load. 2. Disable redundancy function.
	The firmware versions between the two parallel units are different.	Contact the dealer.



Chapter 9: Specifications

Model	RT5K	RT6K	RT10K
1. POWER (VA/ W)	5000VA/ 4500W *1	6000VA/ 5400W *1	10000VA/ 9000W *1
2. WAVE	PURE SINE WAVE		
3. INPUT			
3.1 INPUT VOLTAGE (SINGLE)	100~155V (50%~100% LOAD)		100~180V (50%~100% LOAD)
	156V~280V (100% LOAD) / 281V~300V (90% LOAD)		180V~ 280V(100% LOAD) / 281V~ 300V (90% LOAD)
3.2 INPUT CURRENT	29.7A	35.9A	56.1A
- INRUSH CURRENT	< 200A		
- POWER FACTOR (FULL LOAD)	> 0.99		
3.3 EFFICIENCY (FULL RESISTANCE LOAD)			
- ON LINE MODE (FULL LOAD)	92%		
- ECO MODE (FULL LOAD)	96%		
3.4 INPUT FREQUENCY	40~70Hz		
4. OUTPUT			
4.1 RMS OUTPUT VOLTAGE (SINGLE)	200V/ 208V/ 220V/ 230V (DEFAULT)/ 240V		
4.2 OVERLOAD CAPABILITY	106%~110%: 10MIN; 111%~125%: 5MIN; 126%~150%: 30SEC		
4.3 THE OVERLOAD RELEASE (RATING LOAD)	95%		
4.4 OUTPUT FREQUENCY (BATTERY MODE)	50/60Hz ± 0.05Hz		
4.5 CREST FACTOR (CF)	3:1		
5. BATTERY & CHARGER			
5.1 TYPE	SEALED LEAD-ACID BATTERY		
5.2 NUMBER OF BATTERY	12V x 16PCS	12V x 20PCS	
5.3 CHARGE CURRENT	4A (MAX.)	4A (MAX.)	
6. OPERATION- AUDIBLE NOISE	54dBA *2		
7. APPEARANCE			
7.1 DIMENSIONS- WIDTH x DEPTH x HEIGHT (I/P & O/P BOX INCLUDED)	440.0 x 670.5 x 88.5MM	440.0 x 623.0 x 130.6MM	
7.2 NET WEIGHT	15.5KG	21.3KG	
8. ENVIRONMENT			
8.1 AMBIENT OPERATING TEMPERATURE	0°C~45°C		
8.2 AMBIENT STORAGE TEMPERATURE	-15°C~50°C		
8.3 RELATIVE HUMIDITY	0~95% (NON-CONDENSING)		



NOTE:

- ※ Refer to the rating label for the safety rating.
- ※ All specifications are subject to change without prior notice.
- ※ For power factor modification, please contact your local dealer or customer service.

*1: The power factor can be modified into 0.8 to let the UPS rating change from 5kVA/ 4.5kW, 6kVA/ 5.4kW and 10kVA/ 9kW into 5.5kVA/ 4.4kW, 7kVA/ 5.6kW and 11kVA/ 8.8kW respectively.

*2: At room temperature, at a distance of 1 meter in front of the UPS and when the load is 70% of the rating load.



Chapter 10: Warranty

Seller warrants this product, if used in accordance with all applicable instructions, to be free from original defects in material and workmanship within the warranty period. If the product has any failure problem within the warranty period, Seller will repair or replace the product at its sole discretion according to the situation.

This warranty does not apply to normal wear or to damage resulting from improper installation, operation, usage, maintenance or irresistible force (i.e. war, fire, natural disaster, etc.), and this warranty also expressly excludes all incidental and consequential damages.

Maintenance service with adequate charge is provided for any damage out of the warranty period. If any maintenance is required, please directly contact the supplier or Seller.



WARNING:

The individual user should take care to determine prior to use whether the environment and the load characteristic are suitable, adequate or safe for the installation and the usage of this product. The User Manual must be carefully followed. Seller makes no representation or warranty as to the suitability or fitness of this product for any specific application.

AmplOn RT Series