

Brickcom

Hardware User's Manual

Megapixel Day & Night
Mini Dome Network Camera
Quality Service Group
MD-500Ap & MD-300N Series

Review History:

1. Separate User Manual into HW and SW.
2. Merge MD-500Ap/MD-400Ap/MD-300Ap/MD-200Ap/MD-300Np/MD-200Np/MD-130Np into this User Manual.

Product name: Network Camera (MD-100A series)

Release Date: 2012/05

Manual Revision: V3.0

Web site: www.brickcom.com

Email: support@brickcom.com

info@brickcom.com

©2012 Brickcom Corporation. All Rights Reserved

Table of Contents

| | |
|---|----|
| Before You Use This Product | 1 |
| FCC Warning | 1 |
| Regulatory Information..... | 2 |
| Package Contents | 3 |
| Mini Dome Network Camera Overview | 4 |
| Device Appearance Description | 7 |
| Installation | 8 |
| Hardware Installation | 8 |
| Camera Connection..... | 11 |
| LED Behavior..... | 13 |
| System Requirements..... | 15 |
| Software Installation..... | 16 |
| EasyConfig | 24 |



Before You Use This Product

In many countries, there are laws prohibiting or restricting the use of surveillance devices. This Network Camera is a high-performance, web-ready camera which can be part of a flexible surveillance system. It is the user's responsibility to ensure that the operation of this camera is legal before installing this unit for its intended use.

Upon opening the product's package, verify that all the accessories listed on the "Package Contents" are included. Before installing the Network Camera, read the warnings in the "Quick Installation Guide" to avoid misuse. When installing the Network Camera, carefully read and follow the instructions in the "Installation" chapters to avoid damages due to faulty assembly or installation.

FCC Warning

This device complies with Part 15 of FCC rules.

Operation is subject to the following two conditions;

- (1) This device may not cause harmful interference, and
- (2) This device must accept any interference received, including interference that may cause undesired operations.



Regulatory Information

Federal Communication Commission Interference Statement

This equipment has been tested and found to comply with the limits for a Class B digital device, pursuant to Part 15 of the FCC Rules. These limits are designed to provide reasonable protection against harmful interference in a residential installation. This equipment generates uses and can radiate radio frequency energy and, if not installed and used in accordance with the instructions, may cause harmful interference to radio communications. However, there is no guarantee that interference will not occur in a particular installation. If this equipment does cause harmful interference to radio or television reception, which can be determined by turning the equipment off and on, the user is encouraged to try to correct the interference by one of the following measures:

- Reorient or relocate the receiving antenna.
- Increase the separation between the equipment and receiver.
- Connect the equipment into an outlet on a circuit different from that to which the receiver is connected.
- Consult the dealer or an experienced radio/TV technician for help.

FCC Caution: Any changes or modifications not expressly approved by the party responsible for compliance could void the user's authority to operate this equipment.

This device complies with Part 15 of the FCC Rules. Operation is subject to the following two conditions: (1) This device may not cause harmful interference, and (2) this device must accept any interference received, including interference that may cause undesired operation.



IMPORTANT NOTE:

FCC Radiation Exposure Statement:





This equipment complies with FCC radiation exposure limits set forth for an uncontrolled environment. This equipment should be installed and operated with minimum distance 20cm between the radiator & your body.

This transmitter must not be co-located or operating in conjunction with any other antenna or transmitter.

The availability of some specific channels and/or operational frequency bands are country dependent and are firmware programmed at the factory to match the intended destination. The firmware setting is not accessible by the end user.

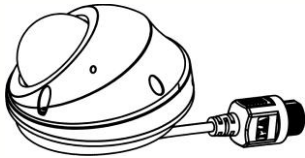
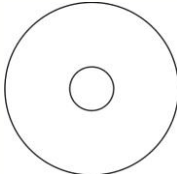
Package Contents

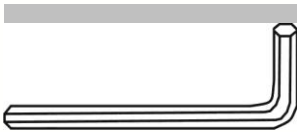
Please check to make sure that the product package contains all the accessories listed below.

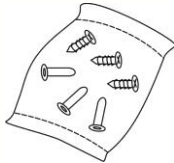
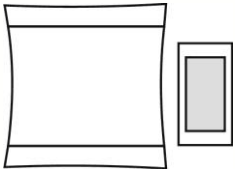
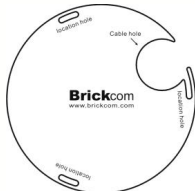
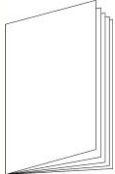
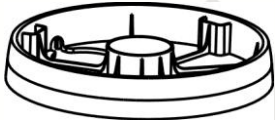
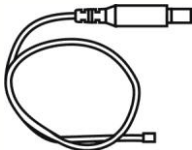
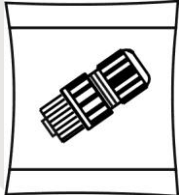
| | |
|---|---|
| <p>a. MD-500A Series/ MD-300Np Series</p>  | <p>b. Product CD</p>  |
| <p>c. Adjusting Lens Tool</p>  | <p>d. Allen Key</p>  |
| <p>e. Warranty Card</p>  | <p>f. Screw Bags(2pcs)</p>  |
| <p>g. Dry Bag / Double-Sided Tape</p>  | <p>h. Alignment Sticker</p>  |
| <p>i. Easy Installation Guide</p>  | <p>j. Mounting Adapter</p>  |
| <p>k. TV out Connector Cable (Optional)</p>  | <p>l. M12 Connector(Optional)</p>  |

Product Comparison

| Model Name | Lens Focal Length | Cable Type | Power Input | | | USB port for 3G/ 4G | |
|-----------------------|--------------------|------------|---------------------|-------------|-----|---------------------|---|
| | | | DC12V | PoE 802.3af | M12 | | |
| MD-500A Series | MD-500Ap-A1 | f=4.00mm | RJ45, DC12V | ✓ | ✓ | - | - |
| | MD-500Ap-A2 | f=3.60mm | RJ45, DC12V | ✓ | ✓ | - | - |
| | MD-500Ap-B1 | f=4.00mm | M12 Connector | - | - | ✓ | - |
| | MD-500Ap-B2 | f=3.60mm | M12 Connector | - | - | ✓ | - |
| | MD-500Ap-C1 | f=4.00mm | RJ45, USB Connector | - | ✓ | - | ✓ |
| | MD-500Ap-C2 | f=3.60mm | RJ45, USB Connector | - | ✓ | - | ✓ |
| MD-300N Series | MD-300Np-A1 | f=4.00mm | RJ45, DC12V | ✓ | ✓ | - | - |
| | MD-300Np-A2 | f=3.60mm | RJ45, DC12V | ✓ | ✓ | - | - |
| | MD-300Np-B1 | f=4.00mm | M12 Connector | - | - | ✓ | - |
| | MD-300Np-B2 | f=3.60mm | M12 Connector | - | - | ✓ | - |
| | MD-300Np-C1 | f=4.00mm | RJ45, USB Connector | - | ✓ | - | ✓ |
| | MD-300Np-C2 | f=3.60mm | RJ45, USB Connector | - | ✓ | - | ✓ |

**This table compliant with MD-500A Series, MD-400A Series, MD-300A Series, MD-200A Series, MD-130A Series, MD-300N Series, MD-200N Series, MD-130N Series.*

Mini Dome Network Camera Overview

The Brickcom MD-500A series/ MD-300N series is a mini dome network camera designed for outdoor use. MD-500A series/ MD-300N series has a compact and stylish design, also provides Full HDTV video (1080p @ 30fps). IP67 certified, IK10 vandal-proof and EN50155 Anti Vibration and Shock, the MD-300A & MD-500A Series is perfect for outdoor surveillance, and surveillance in buses, trains, subway cars and emergency vehicles.

The MD-500A series/ MD-300N series is designed to provide end users with high quality video feed for an easily accessible security system. By offering H.264/M-JPEG/MPEG-4 triple codec compression, it is able to offer a flexible system which does not require high bandwidth and storage capabilities. The internal micro SD/SDHC memory card slot allows for local storage, which prevents data loss if the data connection is lost. The MD-300A & MD-500A Series comes with a wide-angle lens, and Pan 35°/ Tilt 0-90° / Rotation 180° wide angle adjustment, allowing a wide open view for maximum coverage.

Different from other dome cameras, MD-500A series/ MD-300N series supports exchangeable lenses for different conditions. Moreover, MD-500A series/ MD-300N series supports 3G/4G (WiMAX/ LTE) wireless connectivity which allows the camera to transmit video data over wireless networks.

The MD-500A series/ MD-300N series is designed for easy installation. With the BNC TV-Out Connector, the camera can be connected to a monitor which makes it easier for installers to adjust the picture focus while setting up the camera. The MD-500A series/ MD-300N series is

equipped with a special designed mounting adapter and can be installed on a curved surface.

The camera supports different power inputs such as PoE 802.3af, M12 and DC12Vs

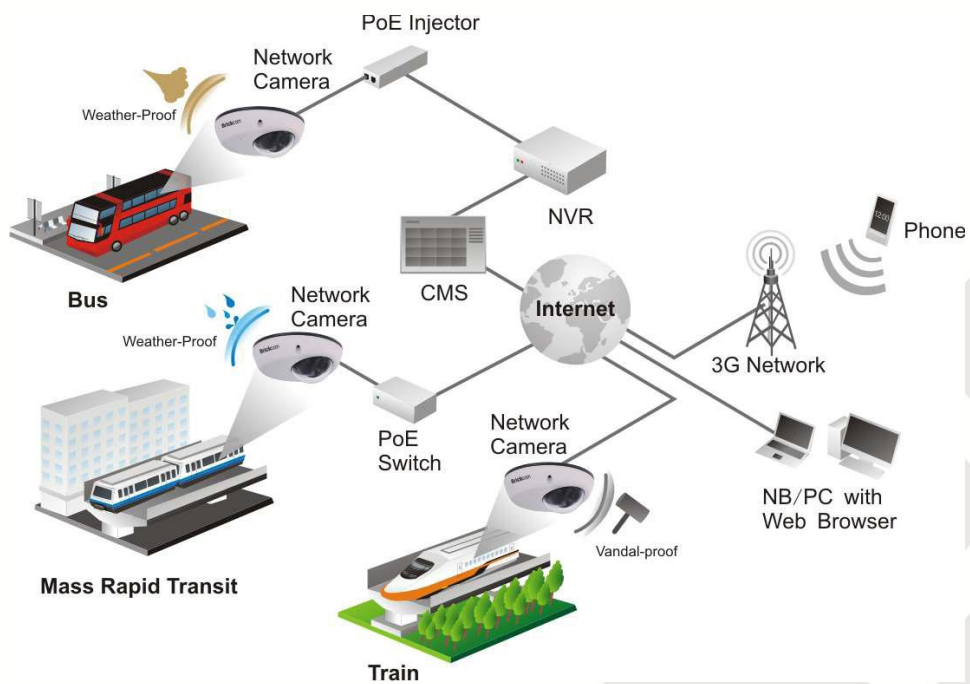

Device Appearance Description

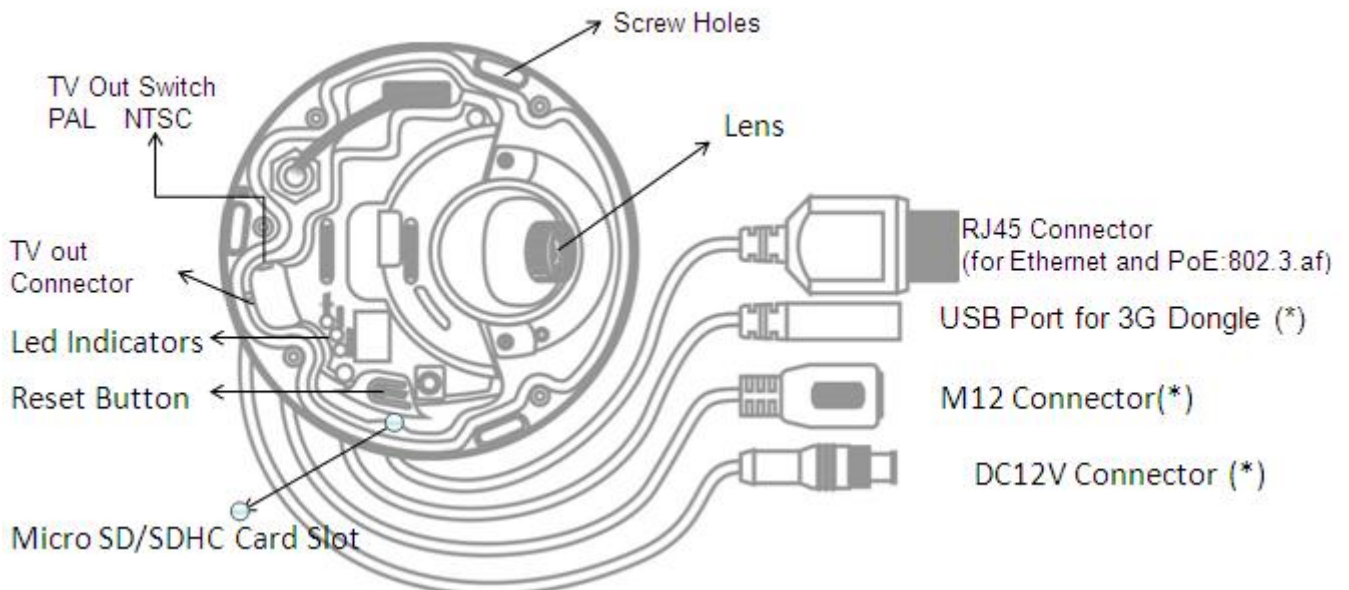

<Outer View>

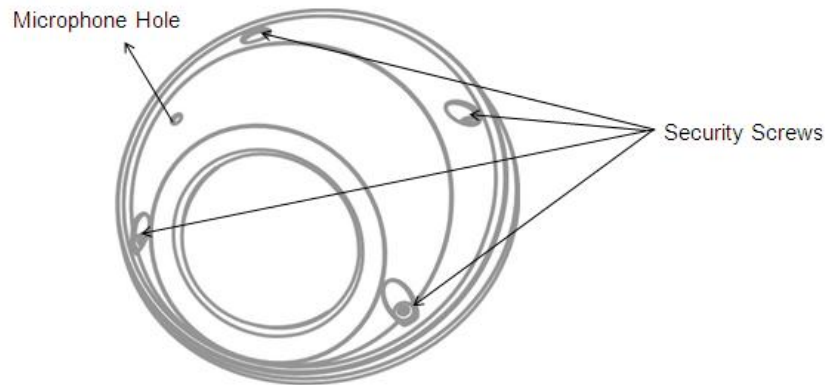

⚠ (*) These are optional features. Please refer to the Product List for the full list of optional features that are available for this product.

Installation

Hardware Installation

WARNING: Do not mount the camera on a soft material. The camera may fall and be damaged.

1. Use the enclosed Allen key to detach the dome cover from the camera device.



As remove the cover, please be aware of the Microphone Line.

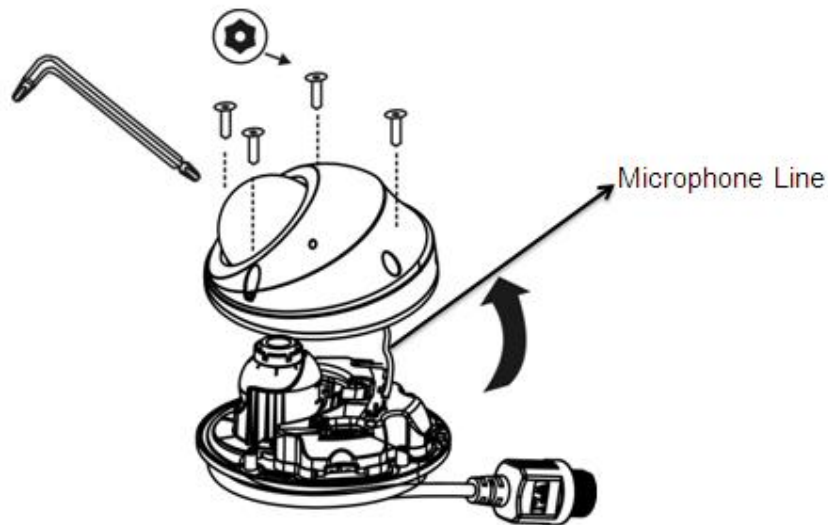

2. Remove the dry bag from its package. Use the double-sided tape to stick the dry bag onto the designate position inside of the dome cover.

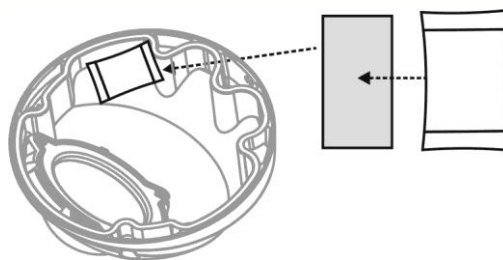

3. Choose the location on the wall or ceiling to place the camera. Attach the location sticker to the desired spot. For ceiling installation, the best place to mount the camera is into a ceiling stud.

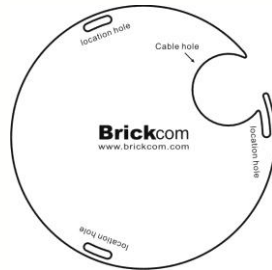

4. Drill three holes through the center of the three location holes on the sticker.

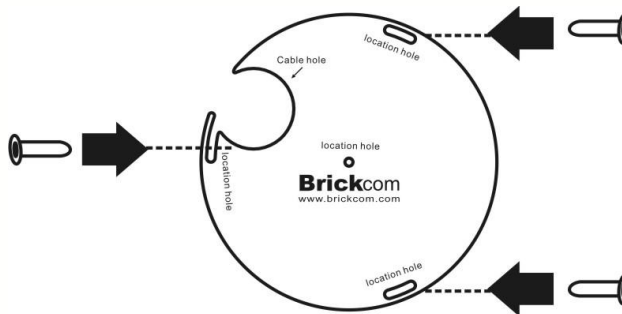

5. Hammer the three plastic anchors which are provided in the product package into the three location holes.

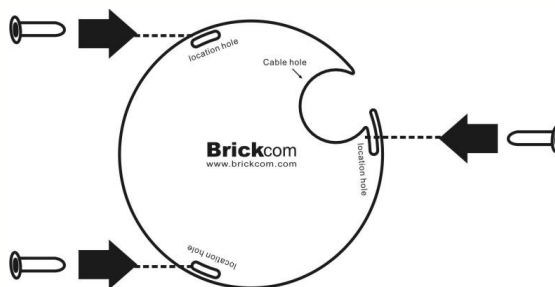

6. Please use the "Waterproof Tape" to wrap around the RJ45 connector, DC12V connector, USB connector (*), in order to prevent water to seep in to the connectors.

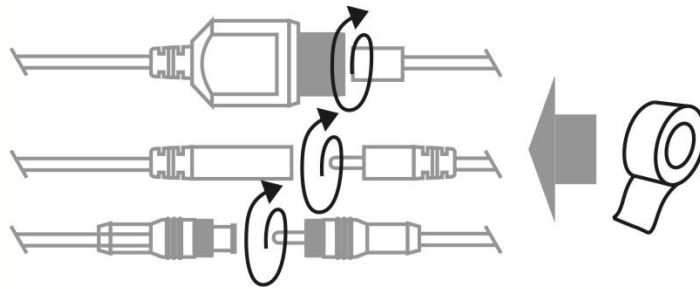

7. The user needs the three screws which are included in the product package and a screwdriver. Mount the camera on the wall or ceiling and position the three screw slots over the plastic anchors. Insert the screws into the holes and use the screwdriver to tighten the screws clockwise until they are secure.

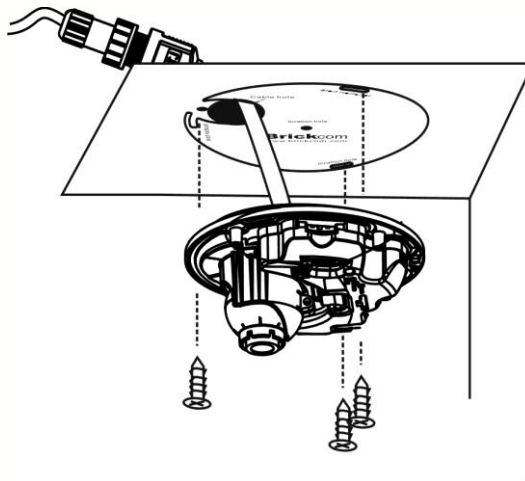

8. If you use the Mounting Adapter, please use the three screws which are included in the product package and a screwdriver. Mount the camera on the wall or ceiling and position the three screw slots over the plastic anchors. Insert the screws into the holes and use the screwdriver to tighten the screws clockwise until they are secure.

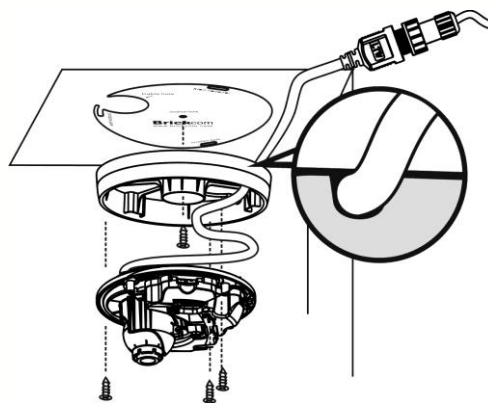

Lens Adjustment

1. Please use the " Adjusting Lens tool" to adjust the lens to the desired position.

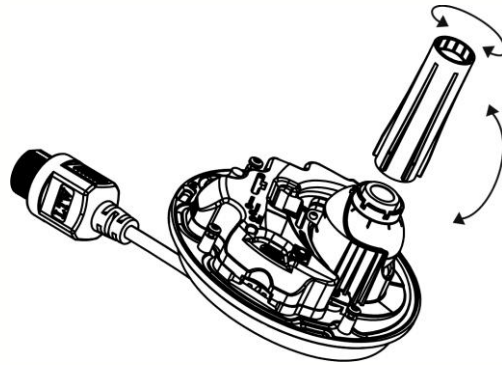

2. Focus

- a. Rotate the lens until the image in the Live View page is focused.
- b. Remove the tool directly.

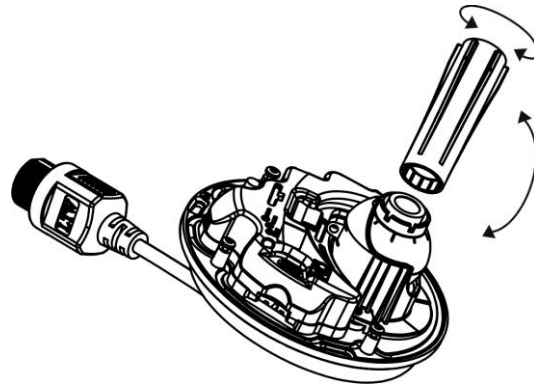

Camera Connection

The New Mini Dome Series is DC12V and PoE compliant, so there are two options for connecting the camera to a power and Ethernet source. The camera can either be connected to a PoE-enabled switch or a non-PoE switch.

a. If using a PoE-enabled switch:

Use a single Ethernet cable to connect the camera to the PoE-enabled switch.

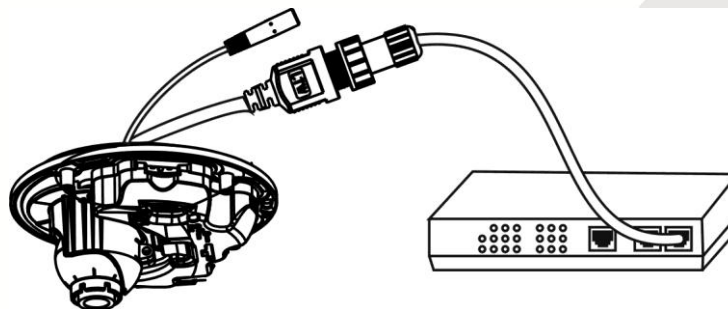

b. If using a non-PoE switch:

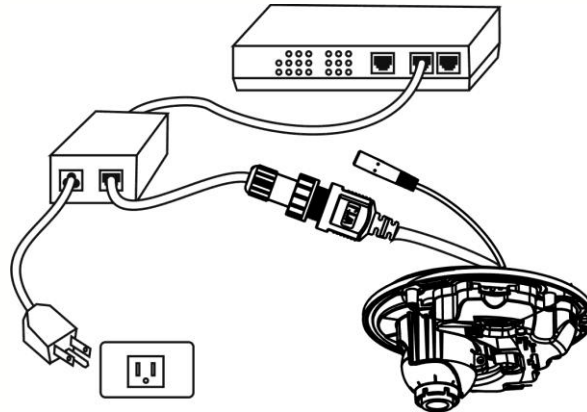

- i. Use a standard RJ-45 cable to connect the camera to a PoE Injector.
- ii. Use a standard RJ-45 cable to connect the PoE Injector to the non-PoE switch.
- iii. Use a standard power cable to connect the PoE Injector to a power outlet.

c. If using the DC12V for the power Supply. The RJ45 cable will be data transmission.

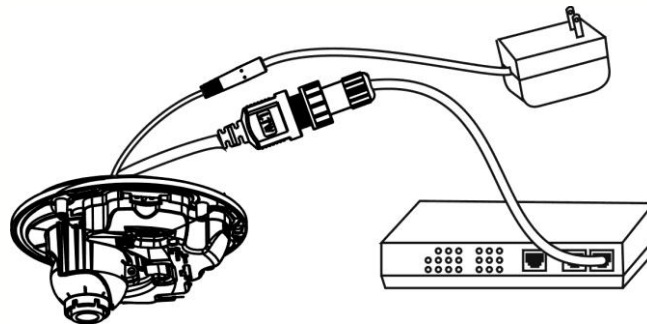

Complete the Installation

Place the dome cover back on the camera device using the Allen Key.

LED Behavior

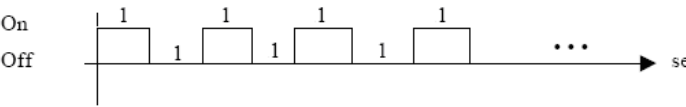
| Function | LED Behavior | Description | Remark |
|----------|---|---|--------|
| Status | Steady On | Normal Operation | Blue |
| Status | Unlit | <ol style="list-style-type: none"> Power off Power on till System setup | Blue |
| Status | On Off  | Upgrading F/W | Blue |
| Internet | Blinking | Blinking while network connection in progress | Blue |
| Internet | Unlit | No connection | Blue |
| Power | Unlit | Power off | Blue |



Hardware Reset

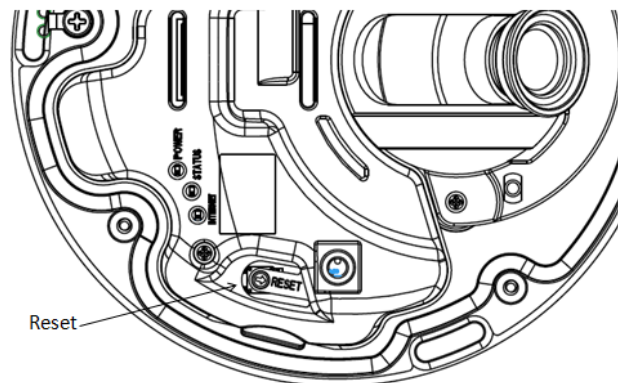

The Reset Button can be used to reboot the camera or restore it to factory default settings. If the camera experiences a problem, rebooting the camera may correct the problem. If the problem remains, please restore the camera to factory default settings and reinstall the software.

To Reboot - Press and hold the Reset Button for one second using a paper clip or thin object. Wait for the camera to reboot.

To Restore – Press and hold the Reset Button for ten seconds until the LED light turns off. When successful restored, the LED will be blue during normal operation.

⚠️ NOTE: By restoring the camera, all settings will be restored to the factory default settings.

Micro-SD/SDHC Card Capacity (*)

The network camera is compatible with Micro-SD/SDHC (Maximum 32GB) cards.

System Requirements

Operating System:

Microsoft Windows XP Home Edition SP2

Microsoft Windows XP Professional SP2

Computer:

IBM PC/AT Compatible

CPU:

Pentium 3GHz or faster

Memory:

1024 MB or more

Monitor:

1024 x 768 pixels or more, 24-bit True color or better

Network Interface:

10/100Mbps Network interface card must be installed

Web Browser:

Microsoft Internet Explorer 6.0 SP2 or higher

Adobe Reader:

Adobe Reader 8.0 or higher

Audio:

The audio function will not work if a sound card is not installed in the PC. Audio may be interrupted depending on network traffic.

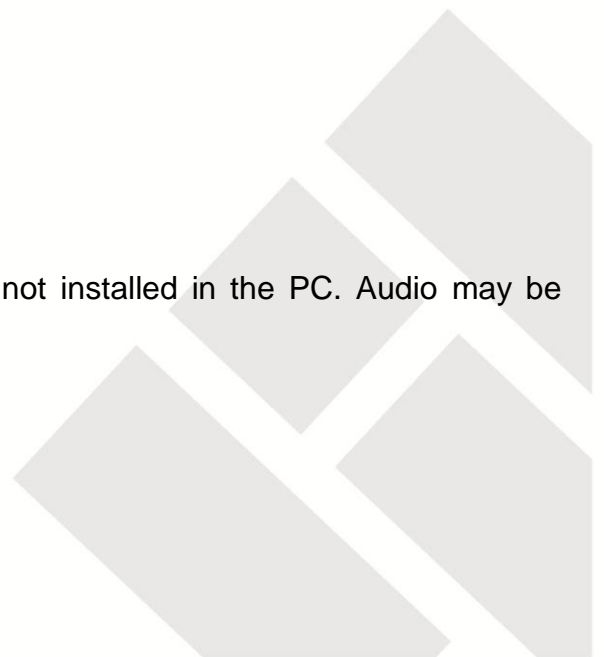

Software Installation

In this manual, "User" refers to whoever has access to the Network Camera, and "Administrator" refers to the person who can configure the camera and grant user access to the camera.

After checking the hardware connection, run the Installation Wizard program included on the product's CDROM to automatically search the intranet for the camera. There may be many cameras on the local network. Differentiate the cameras using the serial number which is printed on the labels on the carton and the bottom of the camera.

1. Insert the Installation CD into the CD-ROM driver. Run Auto-Run Tool directly from the CD-ROM to start the installation. When installing the Brickcom software kit for the first time, select a desired language for the interface. The available languages are listed in the scroll box. Click **<Install>** and follow the steps to install the EasyConfig wizard on the desired computer.



2. In the Install Shield Wizard dialog box, click <Next> to continue.

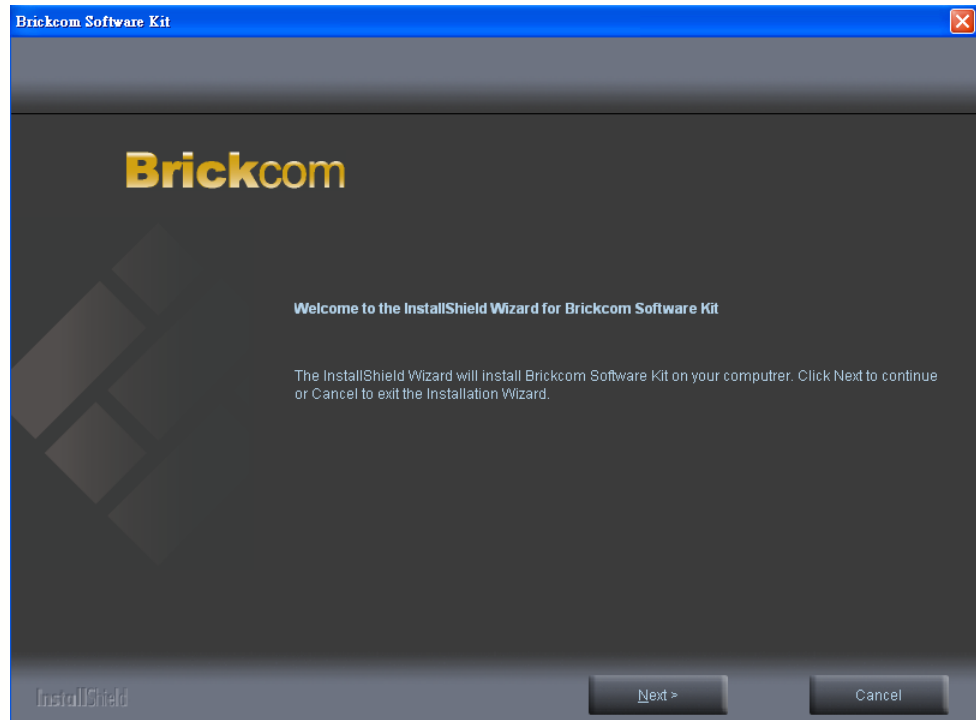

3. Read the End-User License Agreement and check the option "I accept the terms of the license agreement". Click <Next> to continue.

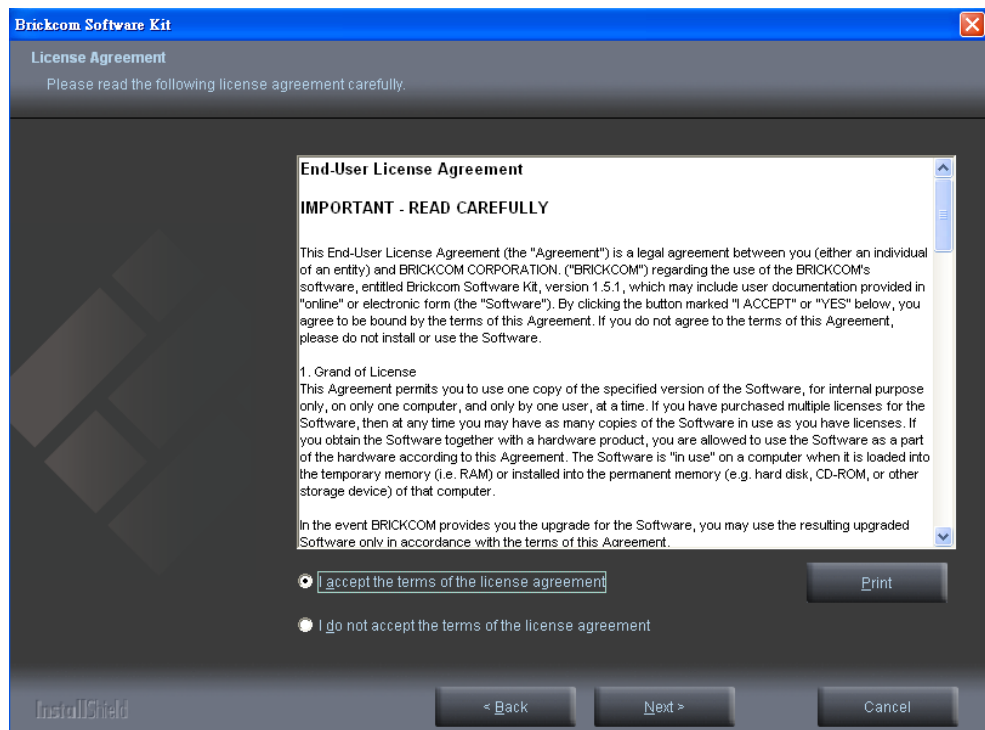

4. Select either “Complete” setup or “Custom” setup to install the system.

a. If **COMPLETE SETUP** is selected:

- i. **All program features** will be installed into the default directory. Check the option “**Complete**” and then click <Next>.

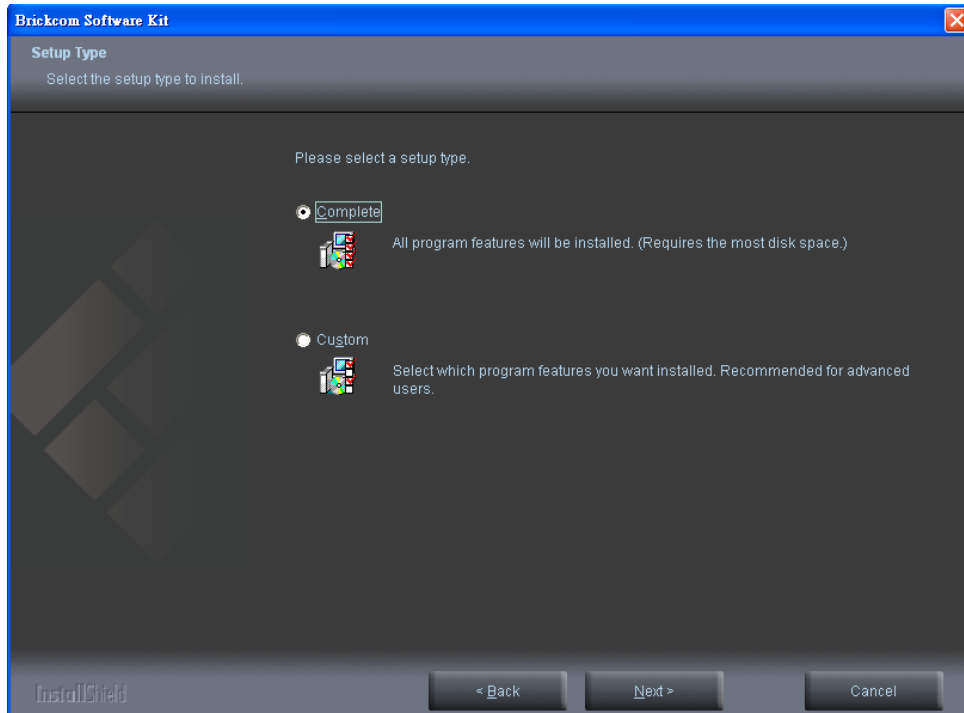

- ii. Click <Change> to change the appointed folder where installation and program files will be stored. Click <Next> to continue.

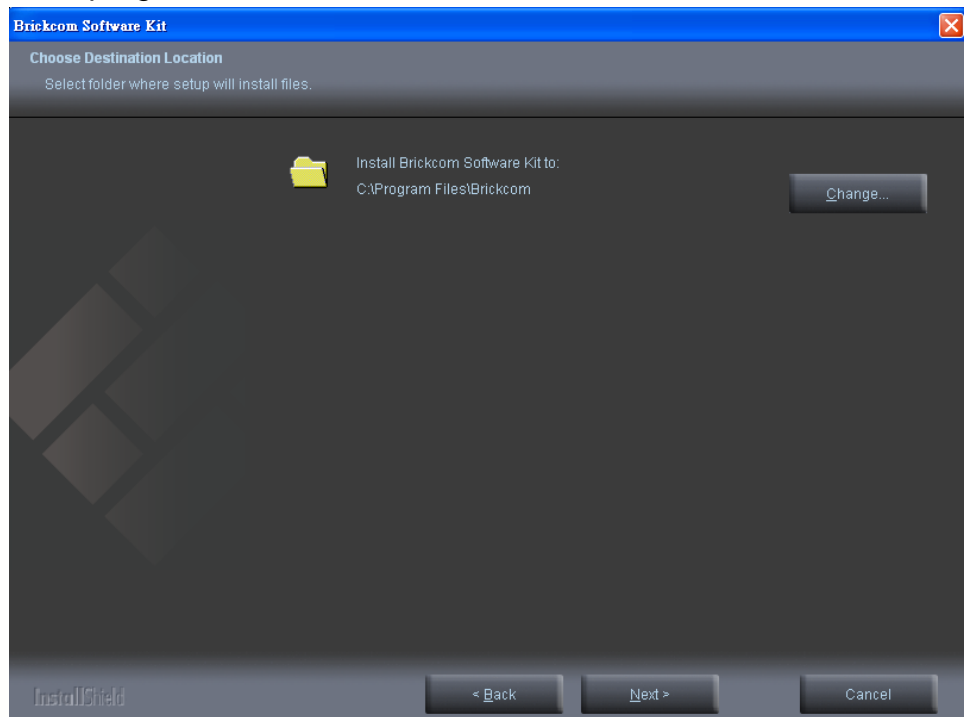

iii. Select to create shortcuts. Click <Next> to continue.

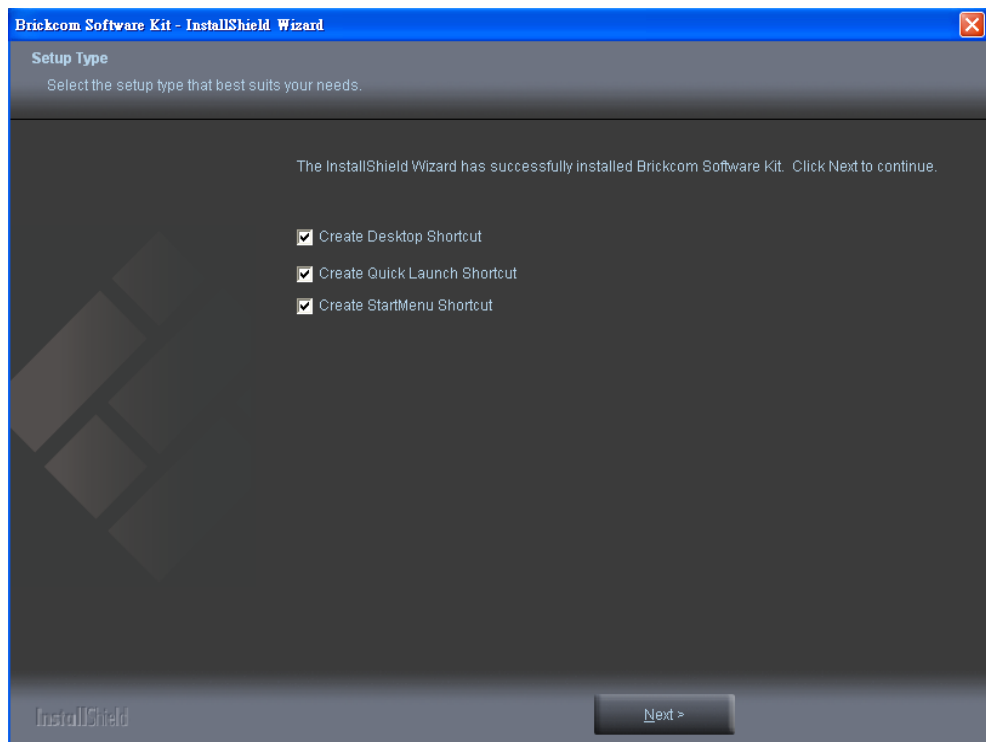

iv. The installation information will be displayed. Click <Next> to continue.

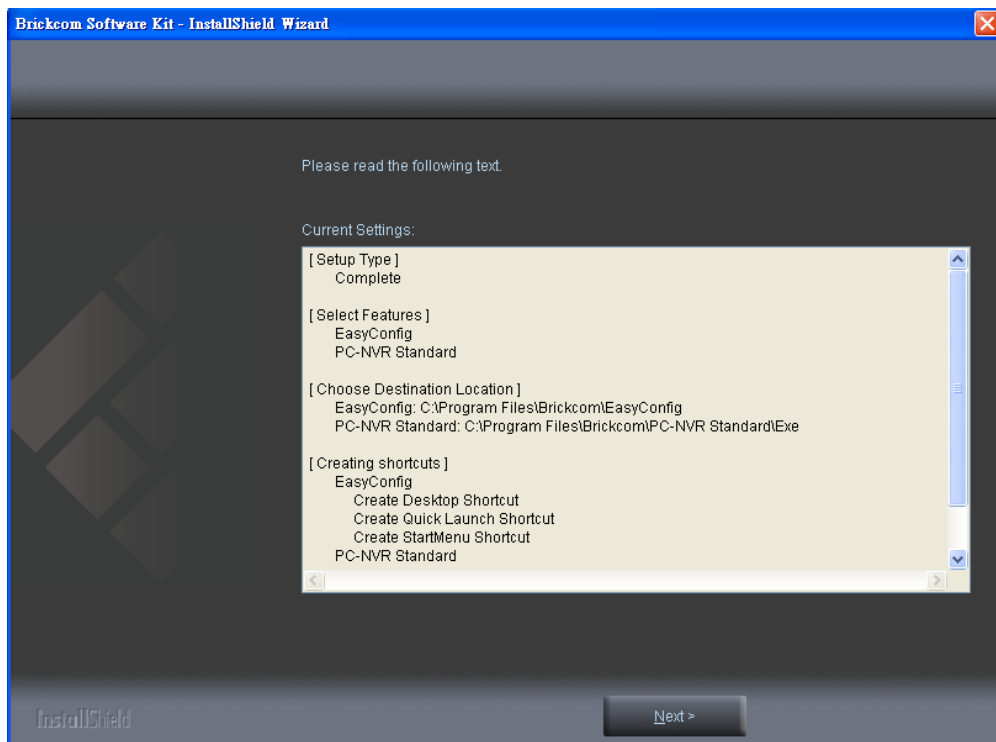

- v. To launch EasyConfig or PC-NVR Standard, select the application and click <Finish>. When launching the PC-NVR program, please refer to the PC-NVR user manual.

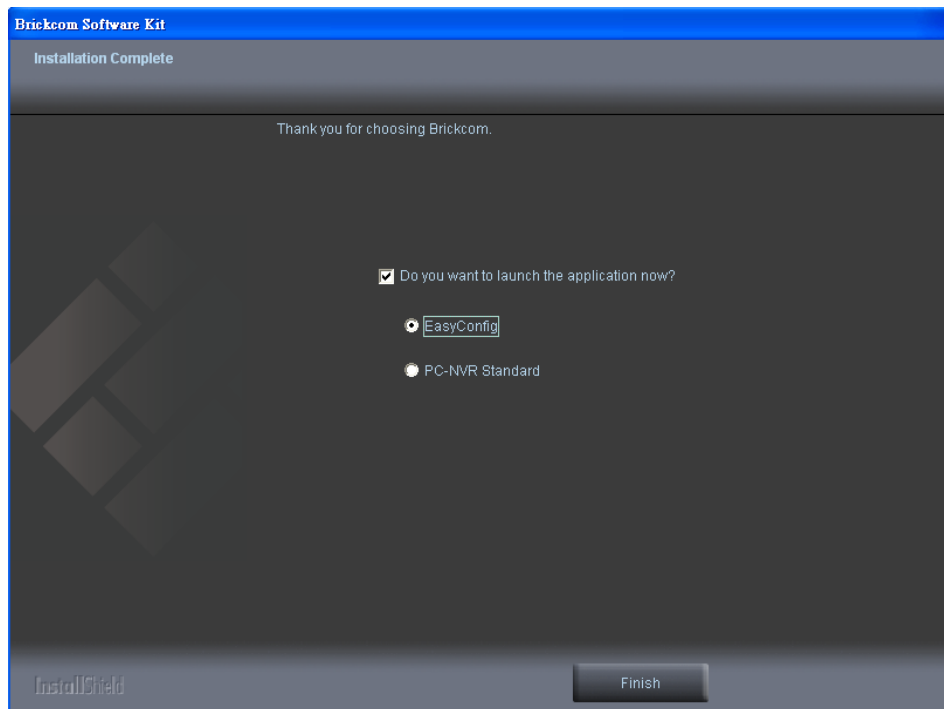

b. If CUSTOM SETUP is selected:

- i. This option is recommended for advanced users. It can be used to install the system to a preferred directory or to select specific program feature(s).
- ii. Check the option “Custom”, and then click <Next>.

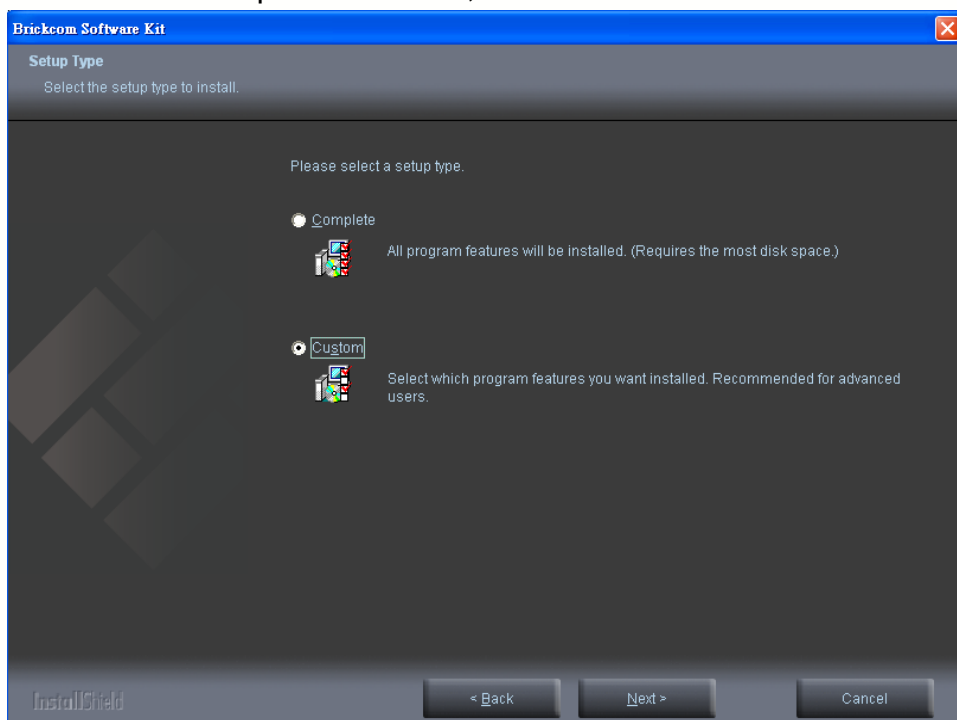

iii. Select the features to install. Click <Next> to continue.

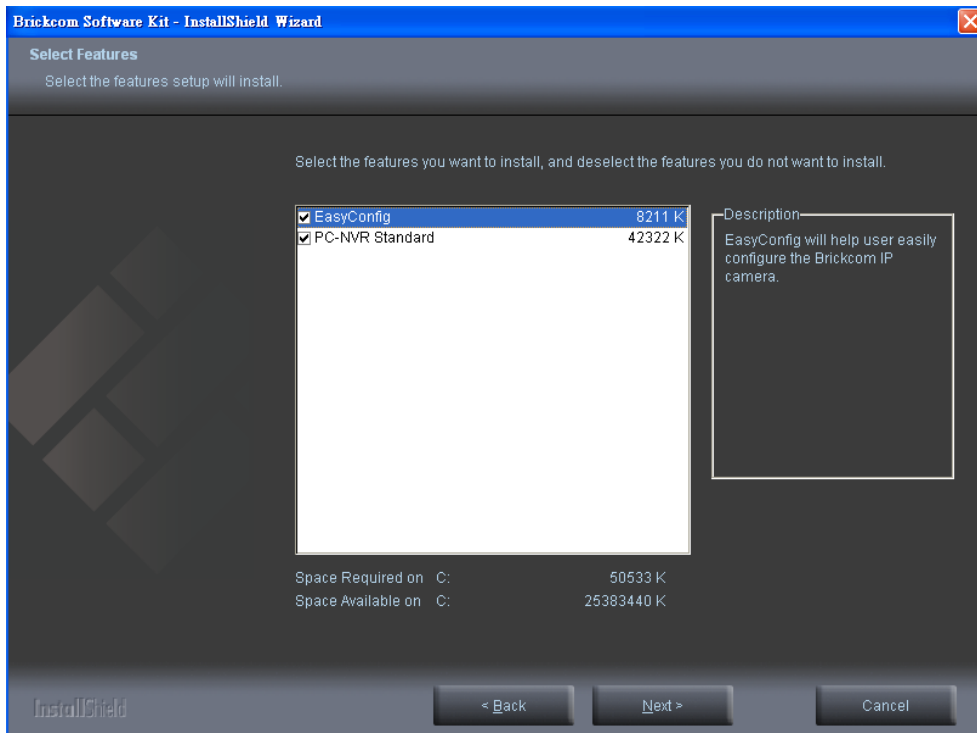

iv. Click <Change> to change the appointed folder where installation and program files will be stored. Click <Next> to continue.

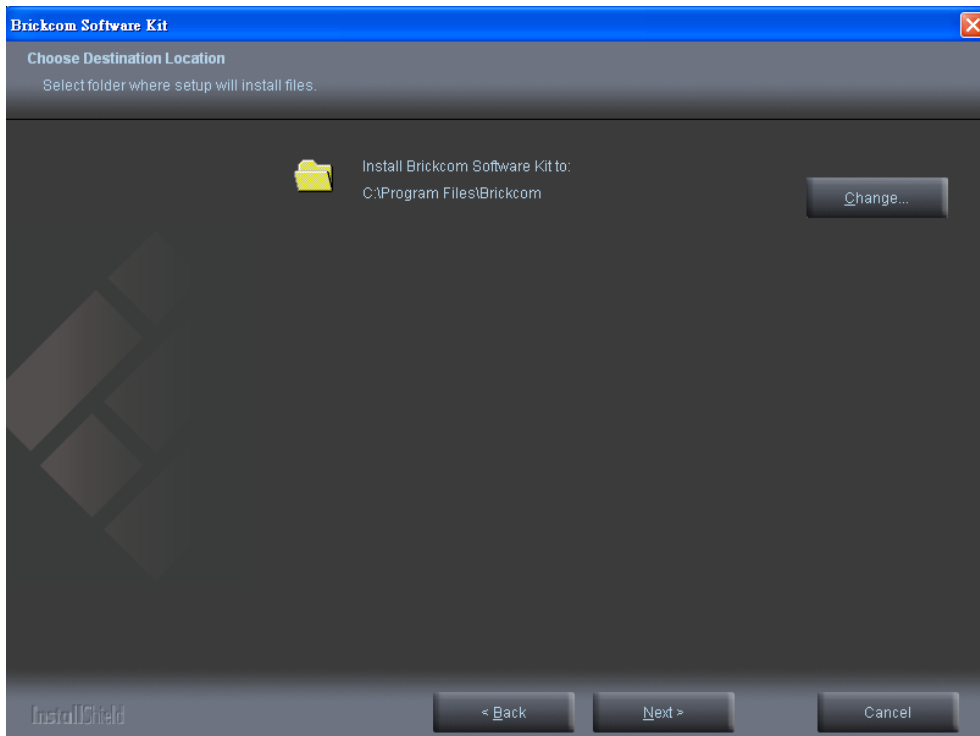

v. Select programs to create shortcuts. Click <Next> to continue.

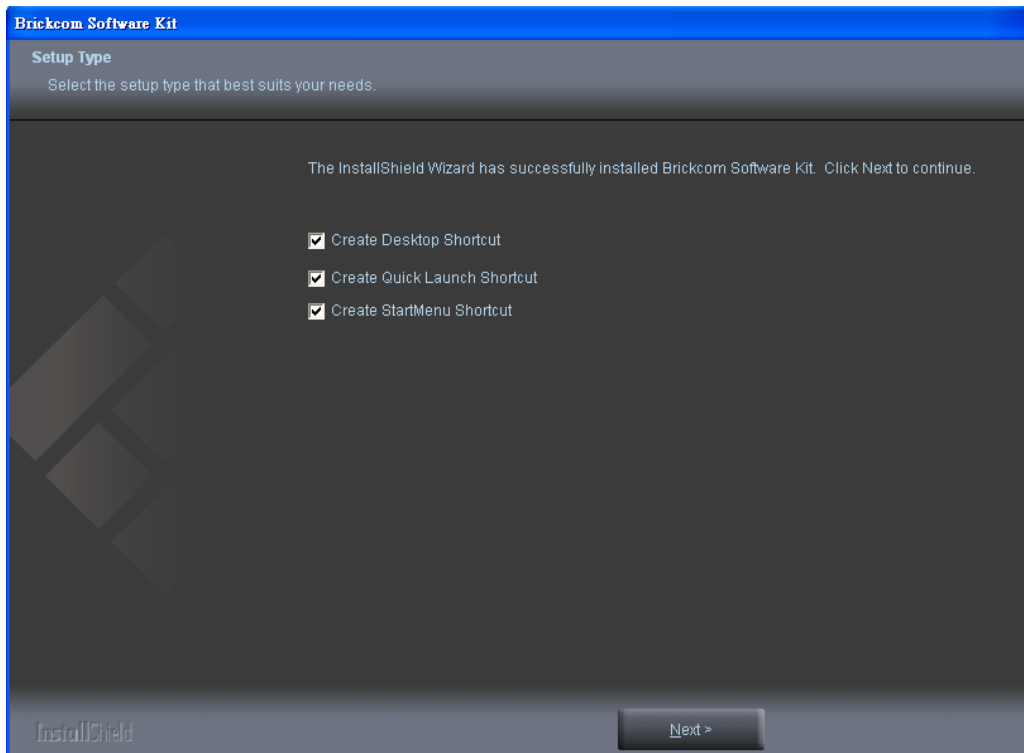

vi. The installation information will be displayed. Click <Next> to continue.

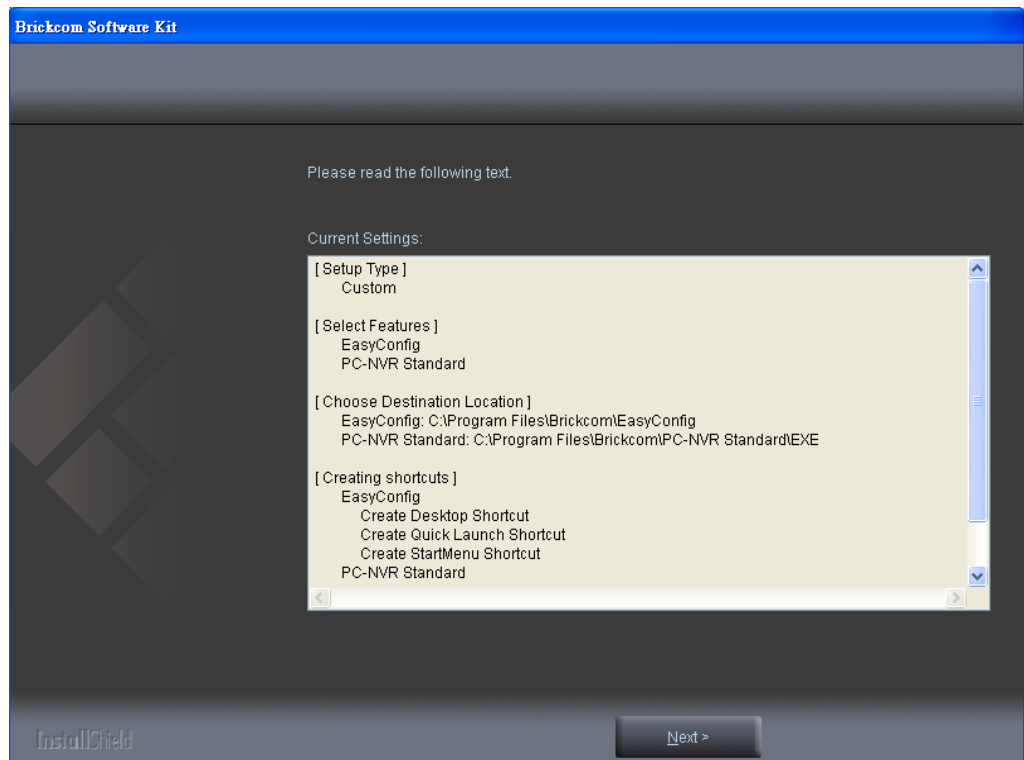

5. To launch EasyConfig or PC-NVR Standard, select the application and click <Finish>. When launching the PC-NVR program, please refer to the PC-NVR user manual.

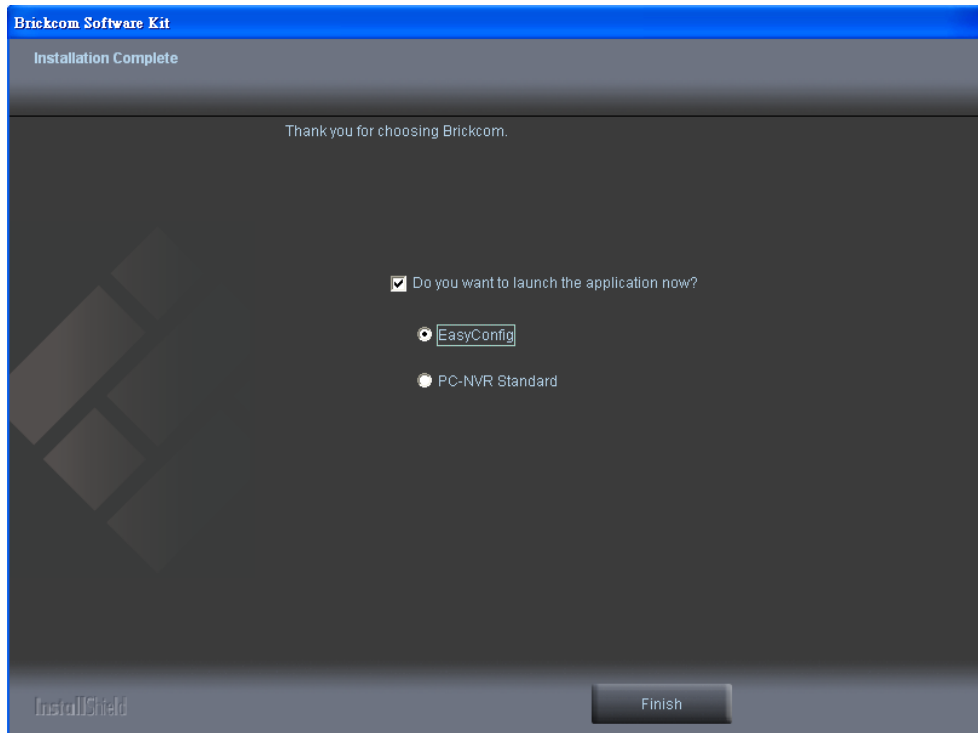

EasyConfig

To launch EasyConfig, select EasyConfig from the start menu. If Complete Setup type was used in the software installation, an EasyConfig icon was installed on the desktop. Double click to open the icon.



If Custom Setup type was used in the software installation and an EasyConfig icon was not installed on the desktop, the program will be installed under C:\Program Files\Brickcom\EasyConfig unless the program was saved to a preferred directory.

1. Click <Start> to continue. The program will automatically search for the camera in the intranet.

 **NOTE** - Check “Skip the hardware installation guide” to skip checking the hardware connection. To check the hardware installation settings, do not check the option box.



Brickcom

Connection

1 Plug one end of the supplied network cable into your network switch or router.

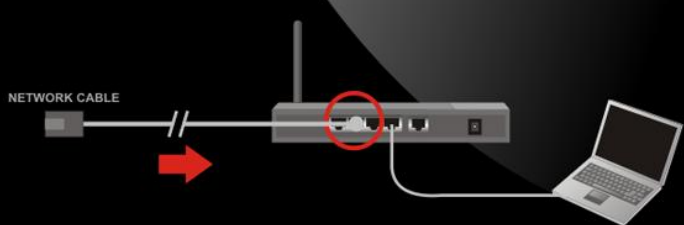

NETWORK CABLE



Brickcom

2 Plug the other end of the supplied network cable into the camera's Ethernet port.

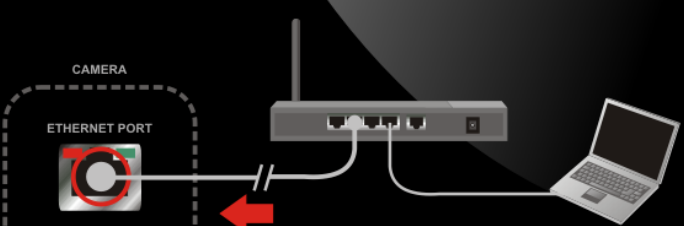

CAMERA

ETHERNET PORT



Brickcom

3 Plug the power adapter into the camera's power port. Then connect the other end into the power outlet. Please check that the LED light is on.

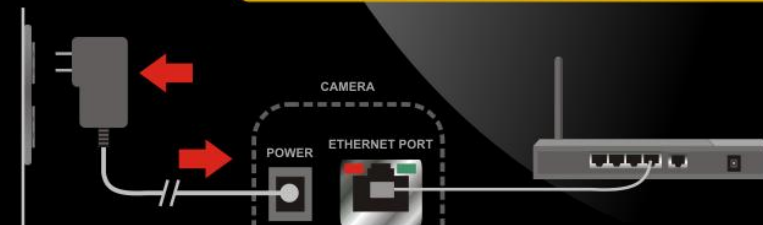

POWER SOCKET

CAMERA

POWER

ETHERNET PORT



2. Select either “Simple Mode” or “Professional Mode” to obtain the camera’s IP settings. If “Simple Mode” is selected, EasyConfig will set up the connection automatically. If “Professional Mode” is selected, the user will need to configure the IP settings manually.



3. There may be many cameras in the local network. Differentiate the cameras using their UPnP name. Double click on the camera from the survey list to connect.

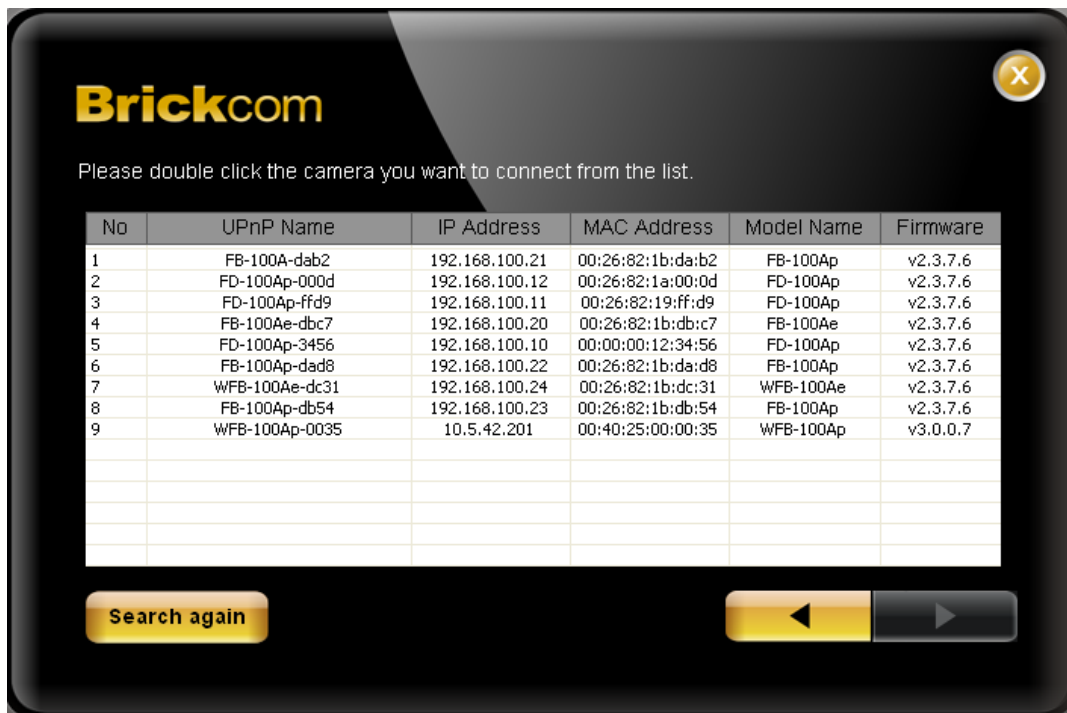

4. Enter the username and password of the camera. For first time use, the default username and password are “**admin/admin.**”

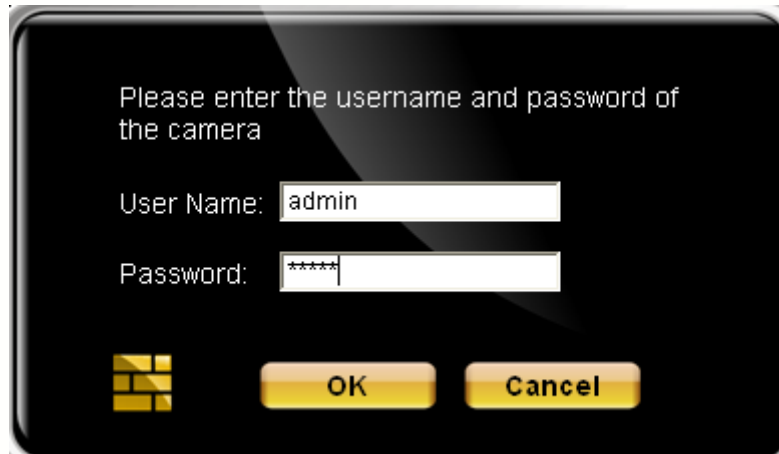

Please enter the username and password of the camera

User Name:

Password:



5. For configuring the IP address settings, select either <Settings remain the same>, <Automatically obtain an IP Address (DHCP)> or <Set IP Address configuration manually>. The DHCP setting is recommended.



Brickcom 

Select the IP Address settings.

Settings remain the same

Automatically obtain an IP Address (DHCP)

Set IP Address configuration manually

- a. If <Set IP Address configuration manually> is selected, the following pages will be displayed.

Brickcom

Select the IP Address settings.

- Settings remains the same
- Automatically obtain an IP Address (DHCP)
- Set IP Address configuration manually

Brickcom

Enter the Static IP Address to configure IP Camera.

IP Address

Subnet Mask

Gateway

DNS1

DNS2

6. If the camera supports the EasyLink™ function, the following page will be displayed. Otherwise, this page will not be shown. *If desired, click <Skip> to skip this setting.



EasyLink™ is a unique Brickcom function which allows users to assign a unique EasyLink name to their network camera's IP address. There is no need to configure the router to open up ports or remember hard-to-memorize IP addresses. Users can log onto [uniqueEasyLinkname].mybrickcom.com to view the camera's web GUI and live view.

- Enter a unique EasyLink name whose length must be between 5-32 characters.
- When finished, click the arrow button to continue.

7. When the IP address settings have been configured, the screen will either display a successful or failed connection message. If the connection failed, either try again or quit the installation.
- If “DHCP IP address settings” was selected, the failure page will be displayed as below:

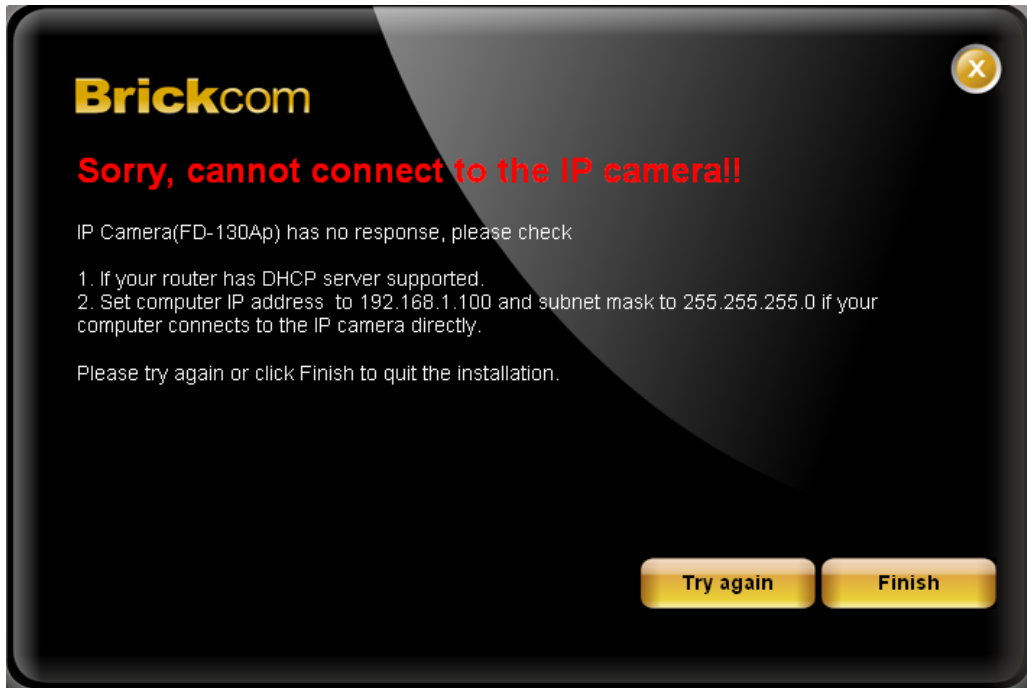

- If “Static IP address settings” was selected, the failure page will be displayed as below:

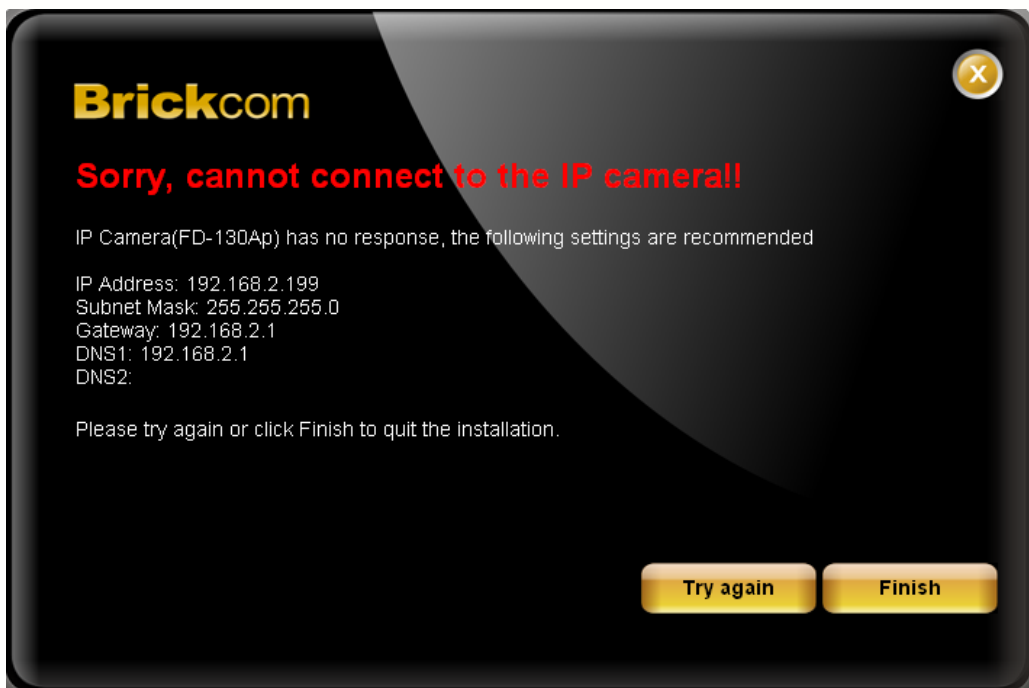

- c. If the connection was successful, the user will see the message:
“Congratulations. The installation of the camera is complete.”

When this window is displayed, click **<PC-NVR>** to start the PC-NVR program, **<Live View>** to view the live video from the connected IP camera, or **<X>** in the top right corner of the screen to close the installation window. If the user starts the PC-NVR program, please refer to the PC-NVR user manual.



Once installation is complete, the Administrator should proceed to the next section "Accessing the Network Camera" for necessary changes and configurations.